



# Installation Instructions

Part No. 30GT-911---049  
 For 115 vac, 60 Hz Control Circuit Applications Only

## SAFETY CONSIDERATIONS

Installation of this accessory can be hazardous due to electrical components and equipment location (such as a roof or elevated structure). Only trained, qualified installers and service technicians should install and service this equipment.

When installing this accessory, observe precautions in the literature, on labels attached to the equipment, and other safety precautions that apply.

- Follow all safety codes.
- Wear safety glasses and work gloves.
- Use care when handling and installing this accessory.

### ⚠ WARNING

Electrical shock can cause personal injury and death. Shut off all power to this equipment during installation. There may be more than one disconnect switch. Tag all disconnect locations to alert others not to restore power until work is completed.

## INTRODUCTION

The ground-fault interrupter convenience outlet (GFI-CO) accessory provides two auxiliary 115 v, 60 Hz outlets for hand tools, lights, and other devices. The GFI-CO also cuts power to the outlets in the event of a ground fault, and includes test and reset switches for this feature. See Table 1 for the contents of the GFI-CO accessory package.

**Table 1 — Accessory Package Contents**

ITEM	PART NO.	QUANTITY
GFI-CO	HY01GF001	1

The 30HXA,HXC076-271 and 30XA080-500 units accept one GFI-CO accessory. The 30HXA,HXC076-271 units provide all necessary wires for accessory installation. However, 30XA080-500 units require field-supplied ground wire for the installation of the GFI-CO accessory.

## INSTALLATION

1. Inspect package contents for missing or damaged parts. File a claim with the shipping agency if parts are damaged, and notify your Carrier representative if any item is missing.
2. Open and tag all electrical disconnects.
3. Open the unit control box door.
4. Install the GFI-CO in the opening provided using the screws provided. See Fig. 1-3.
5. Referring to Fig. 1-3, connect the black wire (in the unit) from FU 1 in 30HXA,HXC units (TB9-L1 in 30XA units) to either brass screw on the GFI-CO. Connect the white wire (in the unit) from TB4-2 in 30HXA,HXC units (TB9-L2 in 30XA units) to either silver screw on the GFI-CO. Connect the green/yellow ground wire (in 30HXA,HXC units and field-supplied for 30XA units) from the GFI-CO to the unit ground near the GFI-CO. All wires are secured in the harness at the GFI-CO location. Remove the factory wire nuts to connect the wires to the GFI-CO outlet.
6. Ensure that electrical connections are tight and restore power to the unit.
7. Test the GFI-CO by pressing its “Test” button and checking for power at the outlet. If the accessory is incorrectly wired, the GFI-CO may not trip and power may be present at the outlet. If power is present, disconnect all power to the unit, correct the accessory wiring, reconnect the unit power, and retest the outlet.
8. When the GFI-CO trips and no power is present at the outlet, restore the circuit by pressing the “Reset” button on the GFI-CO.
9. Remove tags from disconnects and close the control box door.

NOTE: After the GFI-CO is installed, periodically test the ground fault feature as described in preceding Steps 7 and 8.

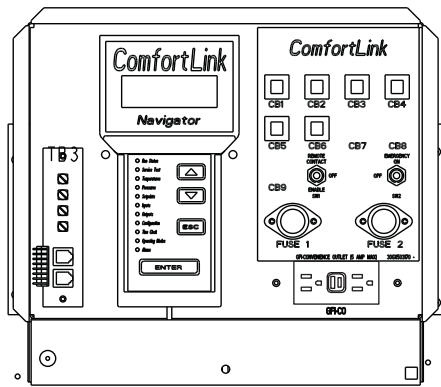

- LEGEND**
- FIOP — Factory-Installed Option
  - FU — Fuse
  - GFI-CO — Ground Fault Interrupter Convenience Outlet
  - TB — Terminal Block
  - Accessory (Field Installed)
  - Wiring (Field-Installed)

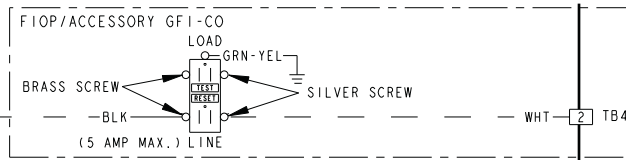
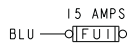

**Fig. 1 — GFI-CO Location and Wiring — 30HXA,HXC076-271 Units**

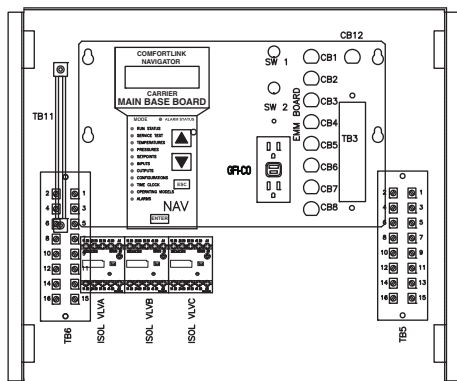

- LEGEND**
- CB — Circuit Breaker
  - FIOP — Factory-Installed Option
  - GFI-CO — Ground Fault Interrupter Convenience Outlet
  - ISOL VLV — Relay Isolation Valve
  - NAV — Navigator
  - SW — Switch
  - TB — Terminal Block
  - Accessory (Field Installed)
  - Wiring (Field-Installed)

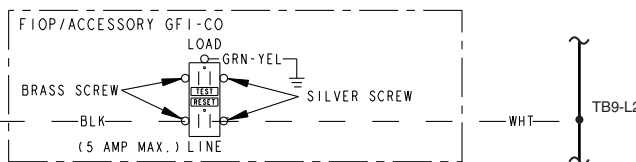
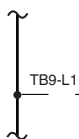

**Fig. 2 — GFI-CO Location and Wiring — 30XA080-122 Units, 200/230 V and 30XA140-500 Units, All Voltages**

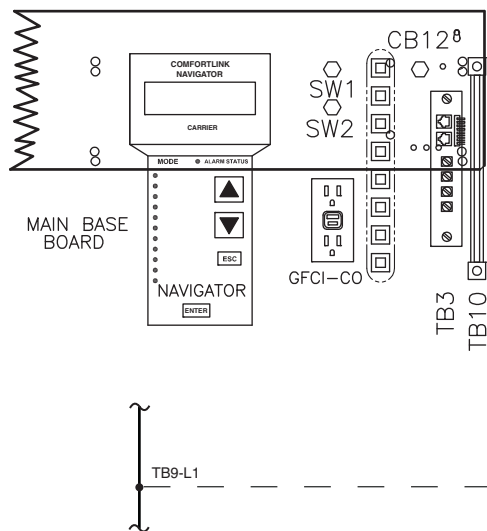

- LEGEND**
- CB — Circuit Breaker
  - FIOP — Factory-Installed Option
  - GFI-CO — Ground Fault Interrupter Convenience Outlet
  - SW — Switch
  - TB — Terminal Block
  - Accessory (Field Installed)
  - Wiring (Field-Installed)

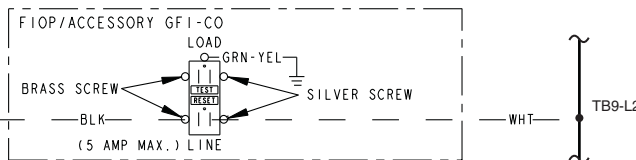

**Fig. 3 — GFI-CO Location and Wiring — 30XA080-122 Units, 460/575 V**