



Installation Instructions

Part Number 30RA-900---007

CONTENTS

SAFETY CONSIDERATIONS	1
INTRODUCTION	1
INSTALLATION	1-8
Install Harness and Make Wire Connections	2
Configure Control (All Sizes)	5
Temperature Reset (4 to 20 mA)	5
Demand Limit (4 to 20 mA)	6
Demand Limit (Switch Controlled)	7
Cooling Set Point (4 to 20 mA)	8

SAFETY CONSIDERATIONS

Installation of this accessory can be hazardous due to system pressures, electrical components, and equipment location (such as a roof or elevated structure).

Only trained, qualified installers and service technicians should install, start up, and service this equipment.

When installing this accessory, observe precautions in the literature, labels attached to the equipment, and any other safety precautions that apply.

- Follow all safety codes.
- Wear safety glasses and work gloves.
- Use care in handling and installing this accessory.

	<p>ELECTRIC SHOCK HAZARD.</p> <p>To avoid the possibility of electrical shock, open and tag all disconnects before installing this equipment.</p>
--	----------------------------------------------------------------------------------------------------------------------------------------------------------

INTRODUCTION

The Energy Management Module Accessory (EMM) (Fig. 1) package is required for additional Temperature Reset, Demand Limit, and Ice Storage features of the *ComfortLink*™ 30RA chillers. Chilled water temperature reset by return water, outside air or space temperature do NOT require the addition of this accessory. The following additional features are supported by this accessory:

- temperature reset by 4 to 20 mA field-supplied signal.
- demand limit control via field-supplied two-step switch input.
- demand limit control by 4 to 20 mA field-supplied signal.
- support of unoccupied operation for ice making through field-supplied contacts.
- cooling set point control by 4 to 20 mA field-supplied signal.

Accessory Package Contents

ITEM	QUANTITY
Energy Management Module, 30GT515218	1
Terminal Block, HY84FE029	1
EMM Mounting Bracket, 30RA500083	1
Terminal Block Mounting Bracket, 30RA500121	1
Harness Assembly, 30RA401210	1
Bushing, HY93NH094	1
Screws, no. 6, 5/8-in. long	2
Screws, no. 6, 3/4-in. long	5
Screws, no. 8, 1/2-in. long	8

INSTALLATION

⚠ WARNING
<p>Before beginning installation of this equipment, be sure all power to the unit is disconnected, and that tags are properly placed to alert others.</p>

1. Inspect the package contents for missing or damaged parts. File a claim with shipping agency if parts are damaged. Notify your Carrier representative if any items are missing.
2. Open and tag all electrical disconnects.
3. Access control box:
 - a. Model 30RA010-030 units: Open control box door and remove inner cover.
 - b. Model 30RA032-055 units: Open center control box door.
4. Loosen the four screws securing the Marquee display bracket. Lift the bracket up and slide it in the holding slots at the top of its mounting bracket. See Fig. 2 and 3.
 - a. Using 4 of the no. 8 screws provided, mount the EMM bracket to the sides of the Marquee display bracket. Install the bushing in the hole in the bracket.
 - b. Using the 5 no. 6 screws provided (3/4-in. long), mount the EMM module to the bracket.
 - c. Using the remaining 4 no. 8 screws, mount the terminal block bracket to the side and top of the existing TB5 bracket.
 - d. Using the 2 no. 6 screws provided (5/8-in. long), mount the terminal block (TB6) to the bracket.
 - e. Remove the metal jumper between TB6-13 and TB6-14.
5. The board address is set through a 4-position DIP switch. All switches should be set to ON.

Install Harness and Make Wire Connections — Locate harness supplied with accessory. Locate plugs marked EMM-J1,J4 (see Fig. 1) in control box factory wire harness. The accessory harness contains connections for EMM-J6, J7 and TB6. Make four plug connections at the

EMM using the connectors labeled EMM-J1, J4, J6 and J7. See Fig. 4. Route remainder of accessory kit harness down through bushing in EMM bracket and route over to TB6. Make all numbered connections to TB6.

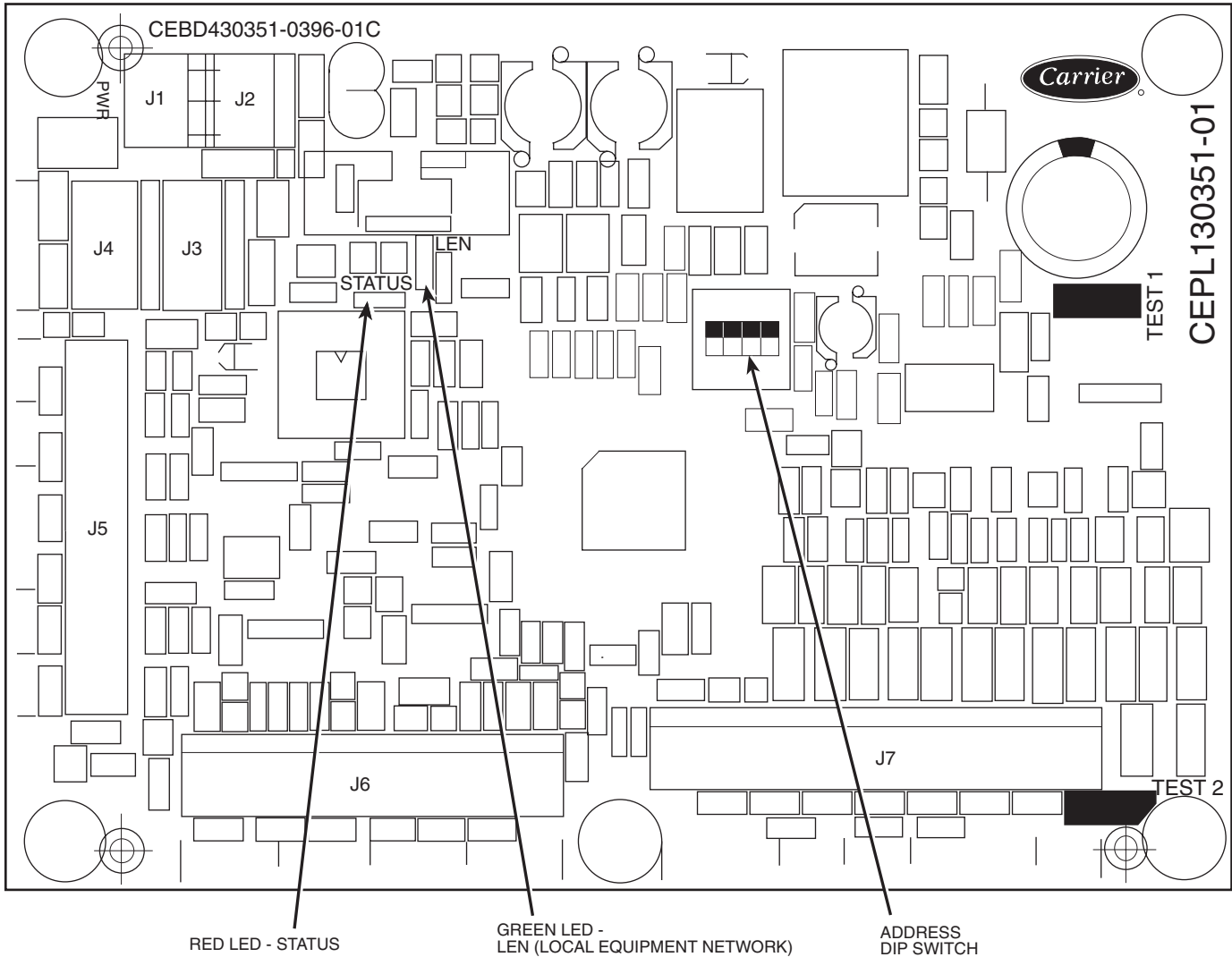
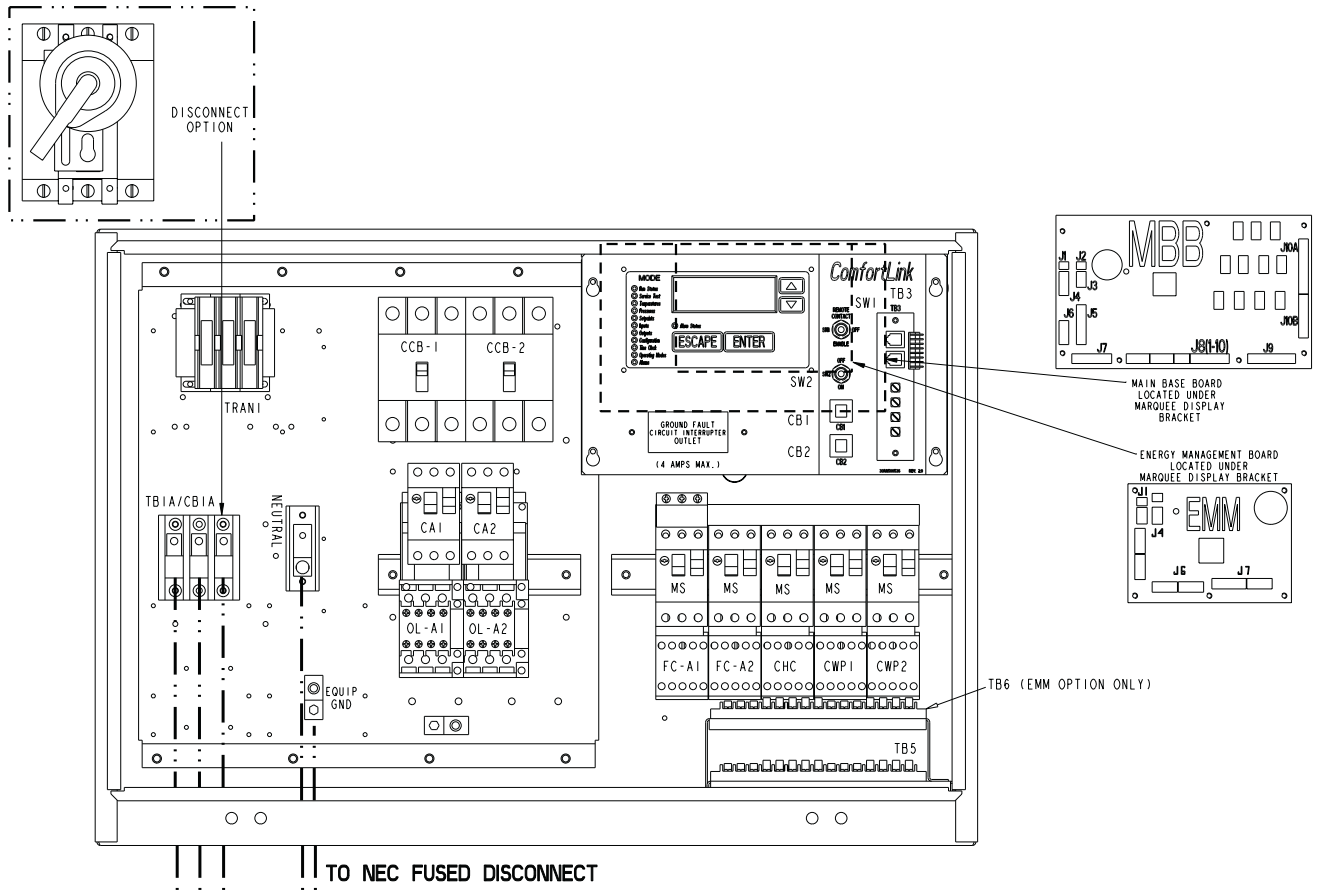
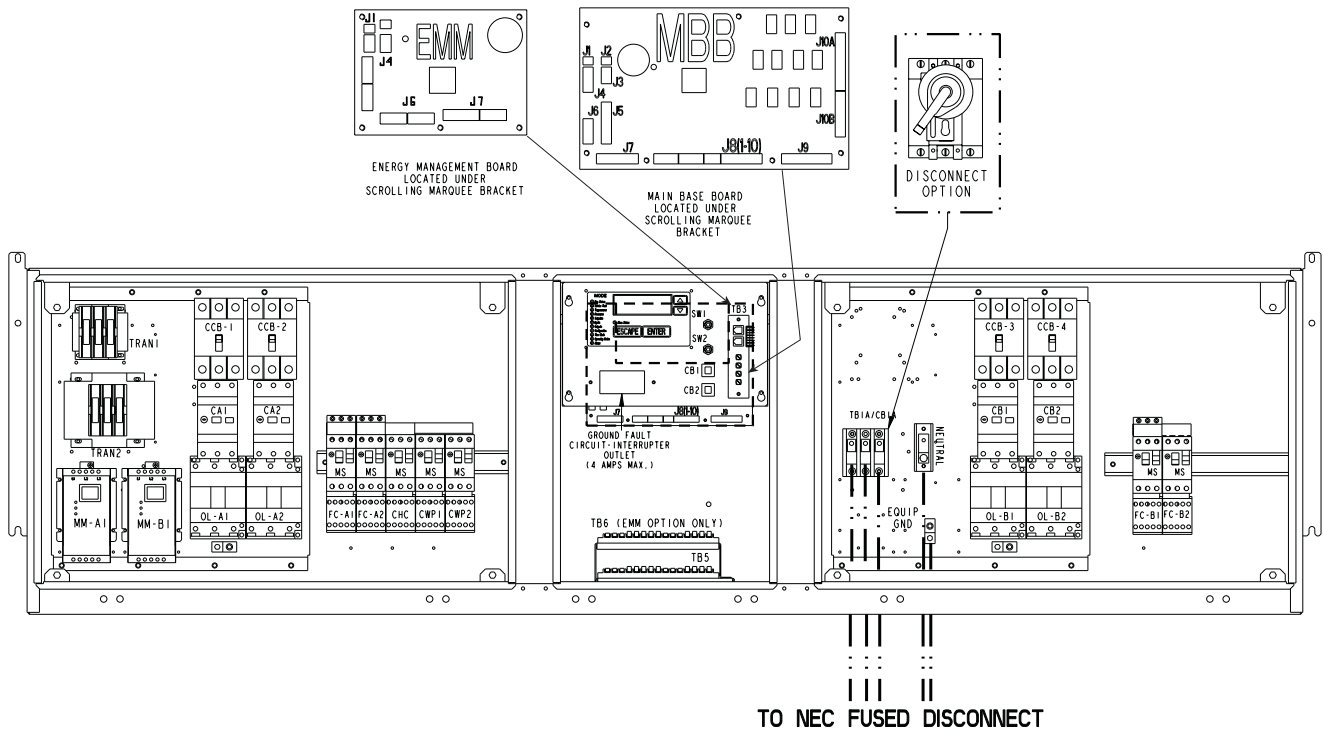

Fig. 1 — EMM Board



→ Fig. 2 — Mounting EMM and Terminal Block, 30RA010-030



→ Fig. 3 — Mounting EMM and Terminal Block, 30RA032-055

LEGEND FOR FIG. 2 AND 3

- | | | | |
|--------------|----------------------------|-------------|---------------------------|
| CB | — Circuit Breaker | TB | — Terminal Block |
| EMM | — Energy Management Module | TRAN | — Transformer |
| EQUIP | — Equipment | | Terminal Block Connection |
| GND | — Ground | | Field Power Wiring |
| MBB | — Main Base Board | | |
| NEC | — National Electrical Code | | |

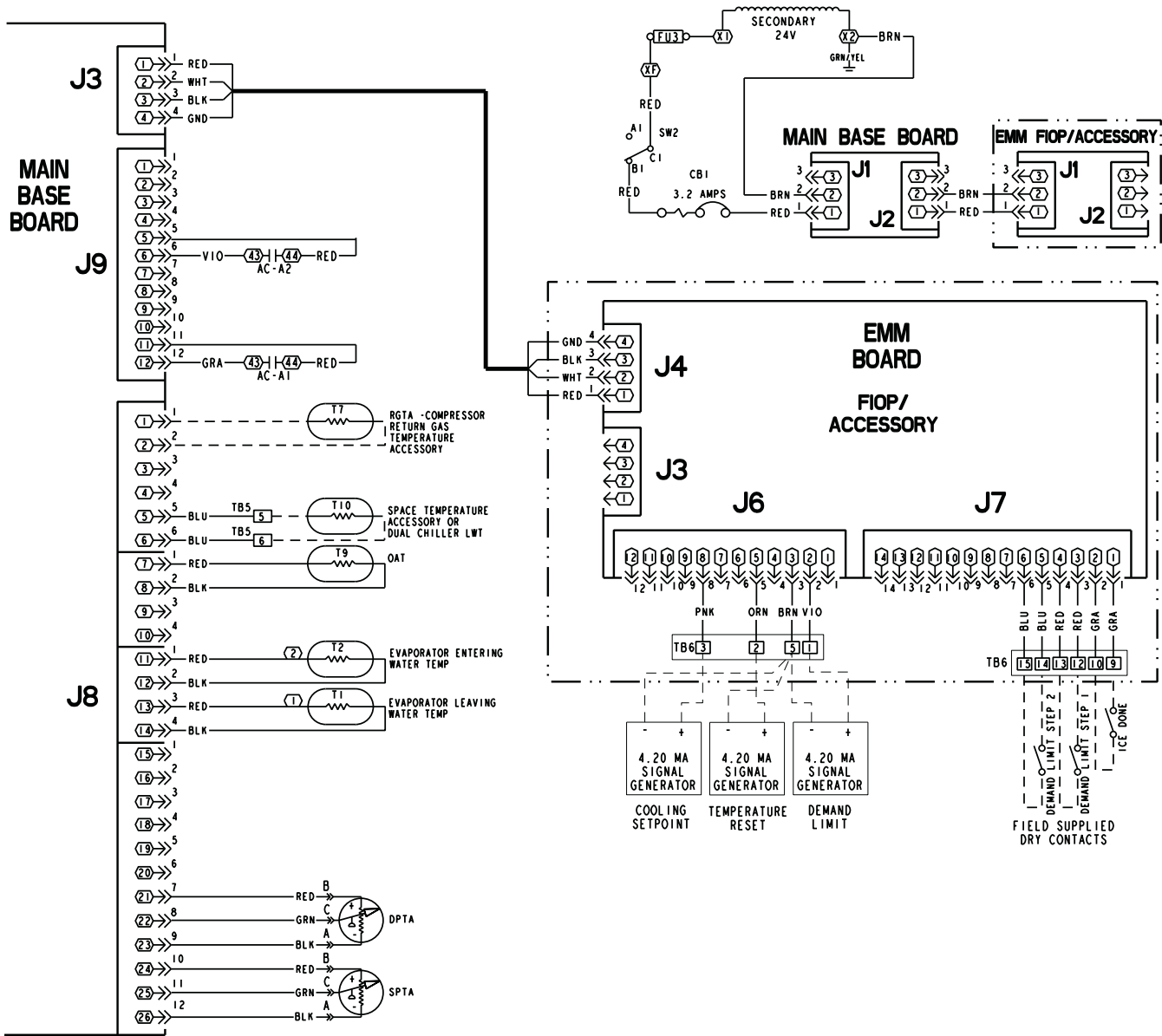







- CB** — Circuit Breaker
EMM — Energy Management Module
FIOP — Factory-Installed Option
- TB** — Terminal Block
TRAN — Transformer
 - - - - Field Wiring

NOTE: Remove factory jumper TB6-13,14.

→ Fig. 4 — Typical Wiring Connections (All Units)

Configure Control (All Sizes)

1. The control must be configured to recognize the EMM. When using the Service Tool for configuration, choose “Modify,” then “Controller” and make the changes as outlined in Tables 1-4. The factory-installed Scrolling Marque Display may be used to do this. With the Scrolling Marque Display, press  until the screen display is blank. Use the arrow keys to select the Configuration mode LED. Follow the steps in Table 1 using the keys on the display.
2. To change the value of EMM, press . Press the down arrow key until OPT1 is displayed. Press . Press the up arrow key to select EMM. Press  and “Enter Password” will be displayed. Press  four times to confirm the password. Use the arrow keys as needed if the password is other than 1111. The NO value will now

be flashing. Press the up arrow key  to change the value to YES and  to accept the change.

Temperature Reset (4 to 20 mA) — A field-supplied and generated, externally powered 4 to 20 mA signal can be used to provide leaving fluid temperature reset. The signal must be connected to TB6. Connect the signal to TB6-2,5 (positive, negative). This is a simple linear function which requires only two configuration changes. Follow the steps outlined in Table 2 to enable the function and configure the reset temperature at 10° F for the 20 mA signal.

The configuration is now complete. As an example, if the cooling set point (CSP.1) is set to 44 F, the control will linearly reset the control point (CTPT) based on the 4 to 20 mA signal. There will be no reset for a 4 mA signal. If the reset signal was 20 mA, the CTPT would be changed to 54 F. Similarly, a 12 mA reset signal would reset CTPT to 49 F. The actual 4 to 20 mA reset signal seen by the control can be viewed by accessing the item RSET, located under the Inputs mode, submode 4-20.

Table 1 — Configuration Mode Menu



















MODE (RED LED)	KEYPAD ENTRY	SUBMODE	KEYPAD ENTRY	ITEM	DISPLAY	ITEM EXPANSION	COMMENTS
CONFIGURATION		DISP					
		UNIT					
		OPT1		FLUD	X	COOLER FLUID	
				EMM	YES/NO	EMM MODULE INSTALLED	DEFAULT: NO CHANGE TO YES
					YES		CHANGE ACCEPTED

Table 2 — Menu Configuration of Temperature Reset Mode

MODE (RED LED)	KEYPAD ENTRY	SUBMODE	KEYPAD ENTRY	ITEM	DISPLAY	ITEM EXPANSION	COMMENTS
CONFIGURATION		DISP					
		UNIT					
		OPT1					
		OPT2					
		RSET		CRST	0	COOLING RESET TYPE	
					0		FLASHING '0'
					1		SELECT '1'
					1		CHANGE ACCEPTED
				MA.DG	0.0	4-20 - DEGREES RESET	SET MAXIMUM RESET AMOUNT FOR 20 mA SIGNAL
					0.0		FLASHING '0.0'
					10.0		SELECT '10.0'
					10.0		CHANGE ACCEPTED

Demand Limit (4 to 20 mA) — A field-supplied and generated externally powered 4 to 20 mA signal can be used to provide leaving fluid temperature reset. The signal must be connected to TB6. Connect the signal to TB6-1,5 (positive, negative). This is a simple linear function which requires only two configuration changes. Follow the steps outlined in Table 3 to enable the function and configure a demand limit of 60% for the 20 mA signal.

The configuration is now complete. There will be no demand limit for a 4 mA signal. If the signal was 20 mA, the chiller capacity (CAP) would be limited to 60%. Similarly, a 12 mA demand limit signal would limit chiller capacity to 80%. The actual 4 to 20 mA demand limit signal seen by the control can be viewed by accessing the item DMND, located under the Inputs mode, submode 4-20.

Table 3 — Menu Configuration of Demand Limit Mode

MODE (RED LED)	KEYPAD ENTRY	SUBMODE	KEYPAD ENTRY	ITEM	DISPLAY	ITEM EXPANSION	COMMENTS
CONFIGURATION	ENTER	DISP					
	▼	UNIT					
	▼	OPT1					
	▼	OPT2					
	▼	RSET	ENTER	CRST	0		
			▼	MA.DG	0.0		
			▼	RM.NO	125.0		
			▼	RM.F	0.0		
			▼	RM.DG	0.0		
			▼	RT.NO	10.0		
			▼	RT.F	0.0		
			▼	RT.DG	0.0		
			▼	DMDC	0	DEMAND LIMIT SELECT	
			ENTER		0		FLASHING '0'
			▲		2		SELECT '2'
			ENTER		2		CHANGE ACCEPTED
			▼	DM20	100	DEMAND LIMIT AT 20 mA	
			ENTER		100		FLASHING '100'
			▼		60		SELECT '60'
			ENTER		60		CHANGE ACCEPTED

Demand Limit (Switch Controlled) — A field-supplied pair of dry contacts can be used to provide one or two steps of demand limit. The dry contacts must be connected to TB6. Connect the contacts for Demand Limit step one to TB6-12, 13. Connect the contacts for Demand Limit step two to TB6-14, 15. This is a step function which will limit the overall chiller capacity to pre-configured percentages when the switch contacts close. Follow the steps outlined in Table 4 to enable the function and configure a demand limit of 70% for step one and 40% for step two.

NOTE: Remove factory jumper between TB6-13, and TB6-14.

The configuration is now complete. The overall chiller capacity (CAP, under the Run Status mode, submode VIEW) will now be reduced to 70% when Demand Limit switch 1 is closed. The capacity will be further reduced to 40% when Demand Limit switch 2 is closed. The actual demand limit switch inputs seen by the control can be viewed by accessing the items DLS1 and DLS2, located under the Inputs mode, sub-mode GEN.I.

Table 4 — Menu Configuration of Demand Limit Mode (Switch Controlled)

MODE (RED LED)	KEYPAD ENTRY	SUBMODE	KEYPAD ENTRY	ITEM	DISPLAY	ITEM EXPANSION	COMMENTS
CONFIGURATION	ENTER	DISP					
	▼	UNIT					
	▼	OPT1					
	▼	OPT2					
	▼	RSET	ENTER	CRST	0		
			▼	MA.DG	0.0		
			▼	RM.NO	125.0		
			▼	RM.F	0.0		
			▼	RM.DG	0.0		
			▼	RT.NO	10.0		
			▼	RT.F	0.0		
			▼	RT.DG	0.0		
			▼	DMDC	0	DEMAND LIMIT SELECT	
			ENTER		0		FLASHING '0'
			▲		1		SELECT '1'
			ENTER		1		CHANGE ACCEPTED
			▼	DM20	100		
			▼	SHNM	0		
			▼	SHDL	0		
			▼	SHTM	60		
			▼	DLS1	80	DEMAND LIMIT SWITCH 1	
			ENTER		80		FLASHING '80'
			▼		70		SELECT '70'
			ENTER		70		CHANGE ACCEPTED
			▼	DLS2	50	DEMAND LIMIT SWITCH 2	
			ENTER		50		FLASHING '50'
			▼		40		SELECT '40'
		ENTER		40		CHANGE ACCEPTED	

Cooling Set Point (4 to 20 mA) — A field-supplied and generated, externally powered 4 to 20 mA signal can be used to provide the leaving fluid temperature set point. Connect the signal to TB6-3,5 (positive, negative). This is a simple linear function one configuration change. See Table 5 for

instructions to enable the function. Figure 5 shows how the 4 to 20 mA signal is linearly calculated on an overall 10 F to 80 F range for fluid types (Configuration mode, item FLUD under OPT1) 1 or 2.

Table 5 — Menu Configuration of 4 to 20 mA Cooling Set Point Control

MODE (RED LED)	KEYPAD ENTRY	SUBMODE	KEYPAD ENTRY	ITEM	DISPLAY	ITEM EXPANSION	COMMENTS
CONFIGURATION	ENTER	DISP					
	▼	UNIT					
	▼	OPT1					
	▼	OPT2					
	▼	RSET					
	▼	SLCT	ENTER	CLSP	0	COOLING SETPOINT SELECT	
			ENTER		0		FLASHING '0'
			▲		4		SELECT '4'
			ENTER		4		CHANGE ACCEPTED

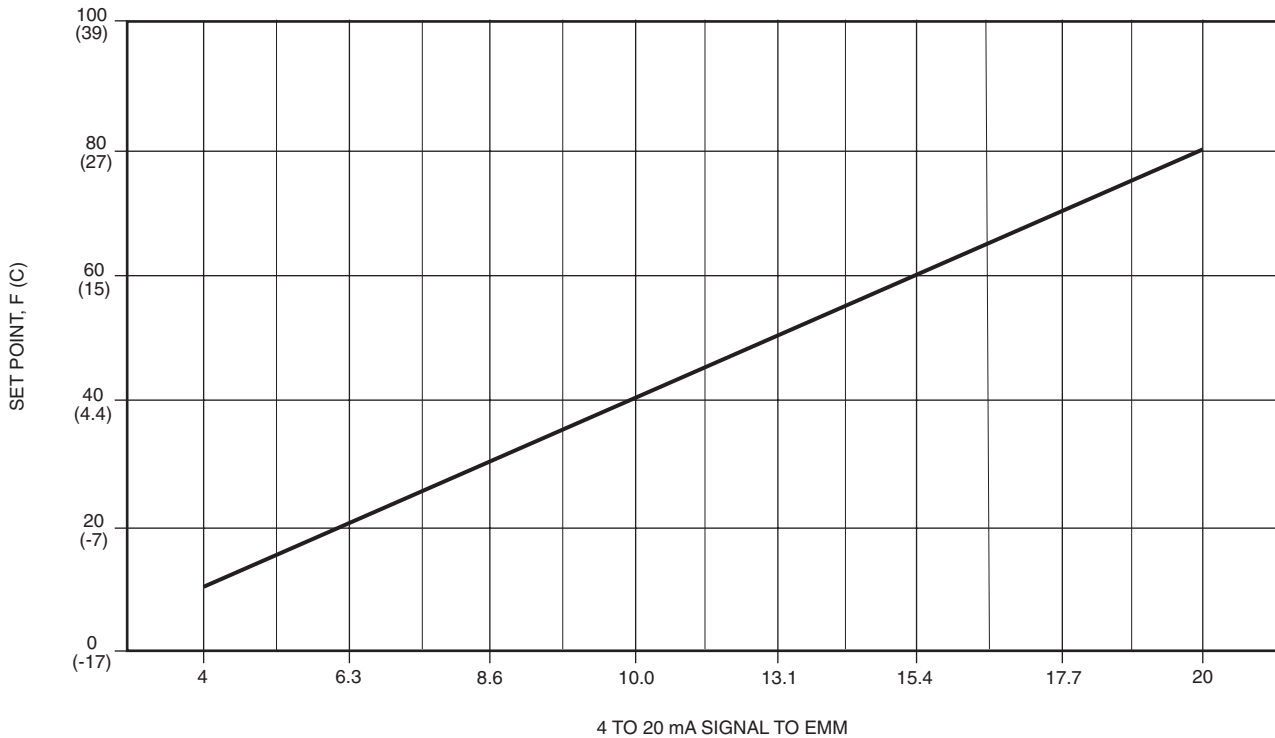

*Fluid Type 1: Water (70 F to 38 F)
 Fluid Type 2: Medium Temperature Brine (70 F to 14 F)

Fig. 5 — Cooling Set Point (4 to 20 mA) [FLUD = 1 or 2]*