



Installation and Operation Instructions

Part Number 33PILOT-01

CONTENTS

	Page
SAFETY CONSIDERATIONS	1
GENERAL	1
INSTALLATION	1-5
Location	1
Power Transformer Wiring	2
Carrier Network Communication Bus Wiring	2
Mounting	2
• RECESS MOUNT	
• SURFACE MOUNT	
• DECORATIVE BACKPLATE	
• SYSTEM PILOT MOUNTING	
OPERATION	6-12
Power-Up Display	6
OAT Display	6
User Interface	6
Attach Screen Navigation	8
Timeout Feature	8
Program Mode	8
• ATTACH	
• CLEAR LIST	
• CLEAR LINE	
• ATTACHING TO AN UNADDRESSED ZONE CONTROLLER	
• CTRLR-ID	
• ALARM HIST	
• TIME/DATE	
• CONFIG, MAINT, SERVICE, SET POINTS, OR STATUS TABLES	
• SCHEDULE	
• SETUP	
• DETACH	
Modifying Set Points	11
Occupancy Override	11
Alternate Maintenance Table	12
Bus Scan	12
CONFIGURATION TABLES	13-18
Alarm Configuration Table	13
Broadcast Configuration Table	13
Holiday Configuration Table	14
Remote Attach Configuration Table	14
System Pilot Configuration Table	16
MAINTENANCE TABLE	18,19
System Pilot Maintenance Table	18

SAFETY CONSIDERATIONS

Air-conditioning equipment will provide safe and reliable service when operated within design specifications. The equipment should be operated and serviced only by authorized personnel who have a thorough knowledge of system operation, safety devices and emergency procedures.

Good judgement should be used in applying any manufacturer's instructions to avoid injury to personnel or damage to equipment and property.

GENERAL

The System Pilot (33PILOT-01) is a component of Carrier's 3V™ system and serves as the user-interface and configuration tool for all Carrier communicating devices. The System Pilot can be used to install and commission a 3V zoning system, linkage compatible air source, universal controller, and all other devices operating on the Carrier communicating network.

Additionally, the System Pilot can serve as a wall-mounted temperature sensor for space temperature measurement. The occupant can use the System Pilot to change set points and cause occupancy overrides. A security feature is provided to limit access of features for unauthorized users.

INSTALLATION

Location — The System Pilot is the command center for the 3V control system and is typically located in the main zone to sense and control temperature in this zone. The System Pilot should be located where it is easily accessible and visible to the end user.

If the System Pilot is being used for system configuration and diagnostics only (not used as a temperature sensor for the attached device), then the location of the System Pilot is not critical for accurate temperature measurement.

For accurate temperature measurement, the following guidelines should be followed. The System Pilot should be mounted:

- approximately 5 ft from the floor
- close to or in a frequently used room, preferably on an inside partitioning wall.
- on a section of wall without pipes or ductwork.

The System Pilot should NOT be mounted:

- close to a window, on an outside wall, or next to a door leading to the outside
- where exposed to direct light or heat from a lamp, sun, fireplace, or other temperature-radiating objects which could cause a false reading
- close to or in direct airflow from supply registers
- in areas with poor air circulation, such as behind a door or in an alcove.

Any zone may use a System Pilot. The System Pilot provides a temperature display and buttons to adjust the desired temperature in that zone only. It also displays outdoor temperature received via broadcast on the Carrier Communicating Network.

The System Pilot is approved for indoor use only and should never be installed with any of its components exposed to the elements. The System Pilot may be installed in any area where the temperature remains between 32 to 104 F, and there is no condensation.

Power Transformer Wiring — An individual, field-supplied, 24 vac power transformer is highly recommended for each System Pilot. Transformers must be UL Class 2 rated. Standard applications require a 24 vac transformer, rated at 40 va typical. All transformer secondaries are required to be grounded. Use only stranded copper conductors for all wiring to the System Pilot.

Wiring connections must be made in accordance with NEC (National Electrical Code) and local codes. Ground one side of the transformer secondary at the transformer location. Connect the system ground of the transformer to the System Pilot terminal JP1-1 (GND). Connect the 24 VAC- side of the transformer to the System Pilot terminal JP1-2 (24 VAC-). Connect the 24 VAC+ live side of the transformer to the System Pilot terminal JP1-3 (24 VAC+). See Fig. 1. The power supply is 24 vac at 60 Hz ± 15%, 10 va minimum.

NOTE: Do not run sensor or communication wiring in the same conduit with line-voltage wiring. Do not run 24-vac wiring in the same multi-conductor cable used for sensors or communications.

Perform the following steps to connect the power transformer:

1. Install the field-supplied transformer in an electrical enclosure that conforms to NEC and local codes.
2. Connect 24 vac from the transformer as shown in the wiring diagram (Fig. 1). Be sure to observe polarity when connecting the transformer power. The grounded terminal must be connected to the transformer ground terminal as shown.

If the system pilot is powered with the same transformer as the other devices, be sure that polarity is maintained and that adequate power is available for all devices. Never power half-wave and full-wave devices on the same transformer or damage may occur to one or both devices.

Carrier Network Communication Bus Wiring —

The System Pilot connects to the bus in a daisy chain arrangement. The System Pilot may be installed on a primary Carrier communication bus or on a local bus wired to a VVT Zone Controller's COMM2 port. When many System Pilots are used, connecting to a local bus is recommended. See Fig. 2 for local bus wiring to a zone controller.

At any baud (9600, 19200, 38400 baud), the number of controllers is limited to 128 zones maximum. Bus length may not exceed 4000 ft, with no more than 60 total devices on any 1000-ft section. Optically isolated RS-485 repeaters are required every 1000 ft.

→ On larger systems with more than 8 linkage coordinators, use bridges to separate the bus into sections. The first device in a network connects directly to the bridge and the others are wired sequentially in a daisy chain fashion. Refer to Fig. 3 for an illustration of Carrier Communication Bus wiring.

COMMUNICATION BUS WIRE SPECIFICATIONS —

The communication bus wiring is field-supplied and field-installed. It consists of shielded three-conductor cable with drain (ground) wire. The cable selected must be identical to the communication bus wire used for the entire network. See Table 1 for recommended cable.

Table 1 — Recommended Cables

MANUFACTURER	CABLE PART NO.
Alpha	2413 or 5463
American	A22503
Belden	8772
Columbia	02525

NOTE: Conductors and drain wire must be at least 20 AWG (American Wire Gage), stranded, and tinned copper. Individual conductors must be insulated with PVC, PVC/nylon, vinyl, Teflon, or polyethylene. An aluminum/polyester 100% foil shield and an outer jacket of PVC, PVC/nylon, chrome vinyl, or Teflon with a minimum operating temperature range of -20 C to 60 C is required.

CONNECTION TO THE COMMUNICATION BUS

1. Strip the ends of the red, white, and black conductors of the communication bus cable.
2. Connect one end of the communication bus cable to the communication port labeled COMM2 (if connecting on a local bus).

When connecting the communication bus cable, a color code system for the entire network is recommended to simplify installation and checkout. See Table 2 for the recommended color code.

Table 2 — Color Code Recommendations

SIGNAL TYPE	CCN BUS WIRE COLOR	PLUG PIN NUMBER
+	Red	6
Ground	White	5
-	Black	4

3. Connect the other end of the communication bus cable to the terminal block labeled Carrier Network Connection on the System Pilot. See Fig. 1. Following the color code in Table 2, connect the Red (+) wire to Terminal JP1-6 (CCN+). Connect the White (ground) wire to Terminal JP1-5 (CCN GND). Connect the Black (-) wire to Terminal JP1-4 (Carrier Network Connection -).
4. If connecting to a Carrier communicating network bus, connect additional devices in a daisy chain fashion, following the color coded wiring scheme in Table 2. Refer to Fig. 3.

NOTE: The communication bus drain wires (shield) must be tied together at each device. If the communication bus is entirely within one building, the resulting continuous shield must be connected to ground at only one single point. If the communication bus cable exits from one building and enters another building, connect the shields to ground at a lightning suppressor in each building where the cable enters or exits (one point only).

Mounting — There are two options for mounting the System Pilot to the wall, recess mounting or surface mounting. The System Pilot will snap together with either the Recess Mount or the Surface Mount backplate.

NOTE: The recess mount backplate is provided with the System Pilot.

RECESS MOUNT — This provides the thinnest mounting configuration (See Fig. 4). The backplate containing the recessed terminal block can be mounted directly to the wall by cutting a hole 1 3/4-in. wide by 2 1/8-in. high. Mark location and cut hole in wall. Ensure the System Pilot location is acceptable before cutting any holes in wall.

SURFACE MOUNT — This provides surface mounting configuration, which allows use of a small hole in the wall. Surface mount backplates may be purchased separately. (See Fig. 5.) Attach backplate and the assembly will mount directly to the wall, requiring only a small hole in the wall allowing the wiring connection to pass through.

Once the System Pilot is secured to wall with the backplate assembly (snapped together), care must be taken not to bend or break the interlocking tabs when removing. Gently remove System Pilot by rocking up/down until interlocking tabs release.

DECORATIVE BEZEL — A decorative bezel may be purchased separately in boxes of 10. See Fig. 6. The bezel can be used to hide any marks/screw holes left from the previous thermostat. This decorative bezel can be used in either the recess or surface mount installation by snapping it onto back of recessed mount backplate or surface mount backplate before securing to wall.

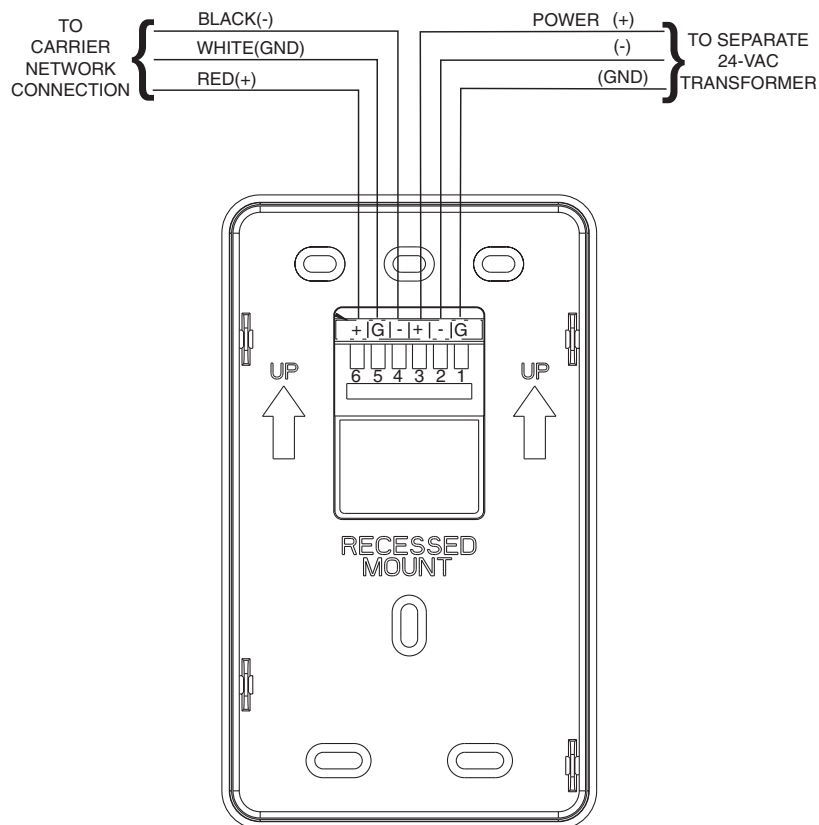

Fig. 1 — System Pilot Wiring

SYSTEM PILOT MOUNTING — Perform the following to mount the System Pilot.

1. Before installing System Pilot, turn off all power to equipment. There may be more than one power source to disconnect.
2. If an existing thermostat or control is being replaced, remove existing control from wall and disconnect wires from existing control. Mark wires for reconnection to System Pilot. Discard or recycle old thermostat or control.

NOTE: Mercury is a hazardous waste, if existing control contains any mercury, it **MUST** be disposed of properly.

3. Select desired System Pilot mounting backplate (recess mount or surface mount and decorative bezel if desired).
4. Route wires through large hole in mounting backplate. Level rear backplate against wall and mark wall through two mounting holes.
5. Drill two $\frac{3}{16}$ -in. mounting holes in wall where marked in Step 4.
6. Secure mounting backplate to wall using two screws and anchors provided.

7. Adjust length and routing of each wire to reach the terminal on the connector backplate. Strip $\frac{1}{4}$ -in. of insulation from each wire.
8. Match and connect thermostat wires to proper terminals on System Pilot backplate. See wiring diagram Fig. 1.

The connector may be removed from the backplate to make terminal connection easier. To remove the connector, use a screwdriver to press the short tabs above the connector. Do not use the screwdriver to press the long tab at the bottom of the connector.

To replace the connector, insert the long tab at the bottom first, then snap in the short tabs at the top.

NOTE: Existing wiring must meet wiring specifications defined in this book.

9. Push any excess wire into the wall. Seal hole in wall to prevent any air leaks. Leaks can affect operation.
10. Attach System Pilot to the mounting backplate by lining up the plastic guides on the back of the control with the opening on the mounting plastic and pushing.
11. Turn on power to equipment.

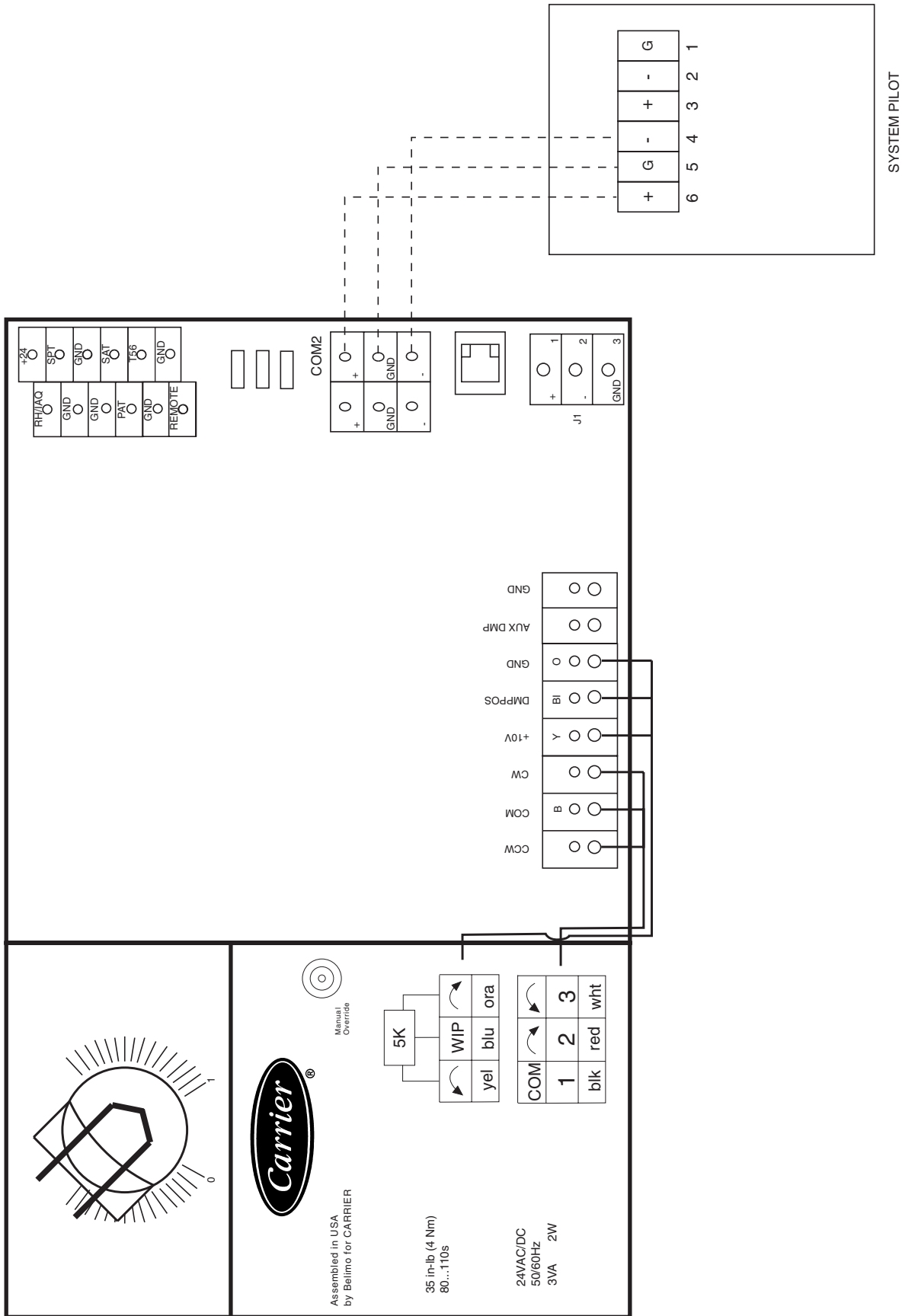
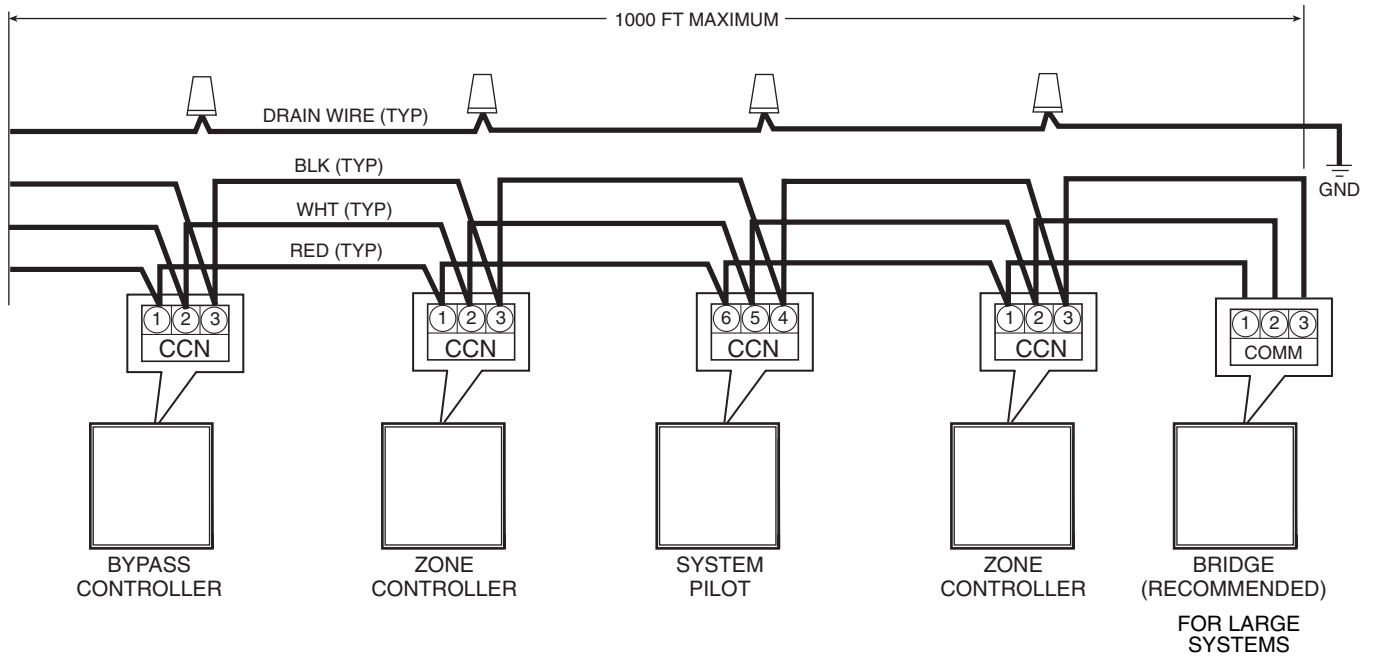

Fig. 2 — System Pilot Connection to VVT® Zone Controller



→Fig. 3 — Carrier Communicating Network Communication Bus Wiring

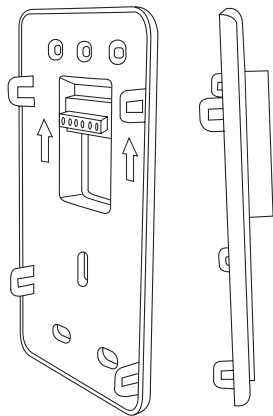

Fig. 4 — Recessed Mount Backplate

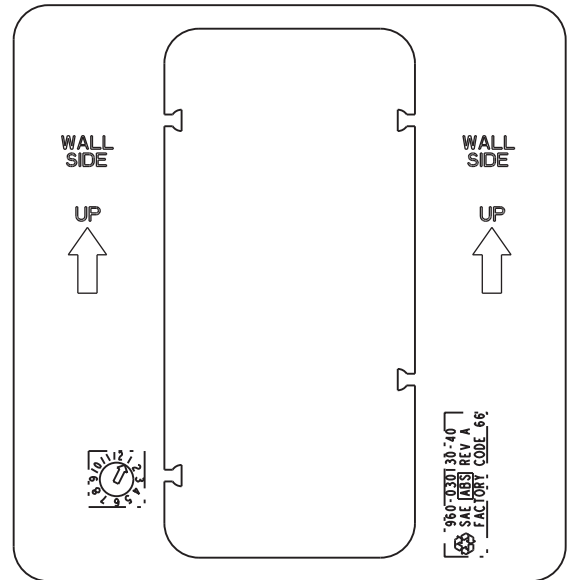

Fig. 6 — Decorative Bezel

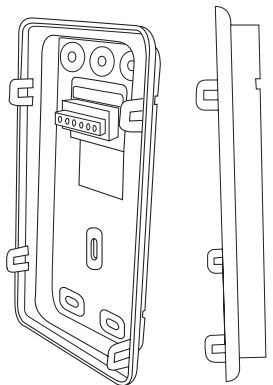

Fig. 5 — Surface Mount Backplate

OPERATION

Power-Up Display — When the System Pilot is powered up, it attaches (initiates communication) to a device that has been designated as the System Pilot's default device. The System Pilot then displays that device's custom Default screen, if such a screen exists. If the System Pilot attaches to an external device that does not have a custom Default screen, the System Pilot reads that device's first status table and displays it as the Default screen.

→ **DEFAULT DEVICE DESIGNATION** — If the System Pilot is connected to a local bus of a VVT® Zone Controller (Comm2), the default device is the local zone controller. If the System Pilot is on the Carrier communication bus, then the default device is user-selectable from the PILOTCON table.

The Local or CCN configuration is set up by the installer in the PILOTCON table. When the System Pilot is configured for Local Operation, time and date will not be displayed on the default screens. When the System Pilot is configured for CCN operation, the time and date will be shown on the default screens. This way a service person or operator may easily determine if the device may be used to access devices on the network. The display of the controller name at the top of the screen in the default display is defaulted to off and may be turned on in the PILOTCON table also.

If the System Pilot is not connected to a local bus and no default device has been configured, the default device is the System Pilot itself. The default device can also be a device that has been designated as the remote attach device (from the REMOTE Table). A remote attach device is a designated Carrier network device to which the System Pilot may write space temperature, compute an operating mode for, and monitor and modify set points.

All custom Default screens display the day of week, time, and space or duct temperature. Other contents will vary according to the attached device type. Examples of Default screens for the System Pilot, VVT Zone Controller, and Bypass Controller are shown in Fig. 7-9.

OAT Display — The System Pilot has an outside air temperature (OAT) software point that can be forced from the

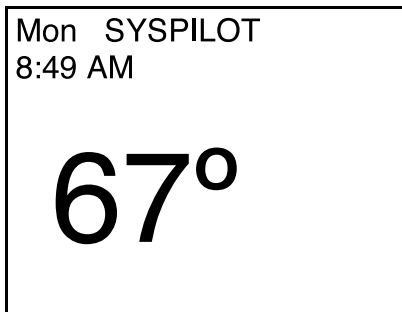

Fig. 7 — System Pilot Default Screen

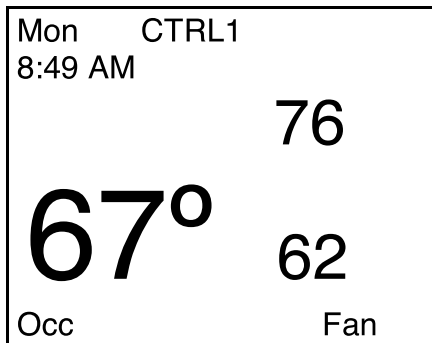

Fig. 8 — Zone Controller Default Screen

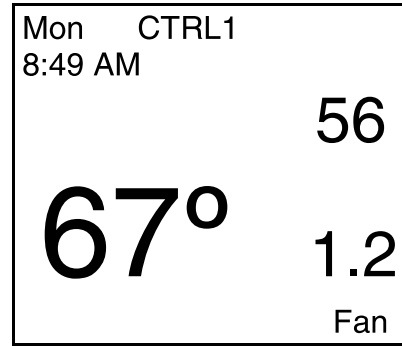

Fig. 9 — Bypass Controller Default Screen

Carrier communicating network. If the System Pilot is displaying any default screen and the EXIT and SELECT buttons are pressed together for one second, the System Pilot replaces the default screen with a special screen that shows the OAT variable value. An example of the OAT Display screen is shown in Fig. 10. When the System Pilot is connected to the Zone Controller's local bus (Comm2), the OAT display feature is disabled.

User Interface — The System Pilot contains six buttons and two rotary knobs with buttons, which allow the user to navigate through the menus, select the desired options, and modify data. See Fig. 11.

SCROLL UP/SCROLL DOWN — If displaying a table or a list of items, these buttons move the cursor to the next line or previous line in the table or list.

If the System Pilot is displaying a controller Default screen and the SCROLL UP and SCROLL DOWN buttons are pressed together for 3 seconds, the System Pilot changes to Program mode.

The current security level can be overridden and full program mode capability can be obtained by using the following button sequence while a Default screen is displayed. Press the SCROLL DOWN and PAGE UP buttons together for 1 second, followed by the SCROLL UP and SCROLL DOWN buttons pressed together for 3 seconds. The button pushes in the sequence must be separated by no more than one second. The override into full program mode is a one-time override.

Pressing the SCROLL UP button along with the INC/DEC button increases or decreases the contrast on the System Pilot LCD display screen.

PAGE UP/PAGE DOWN — In screens that have more than 7 data lines (Ex: a Table List screen with more than 7 tables, or a table with more than 7 decisions), these buttons replace the items currently on the screen with the previous or next 7 items from the table or list.

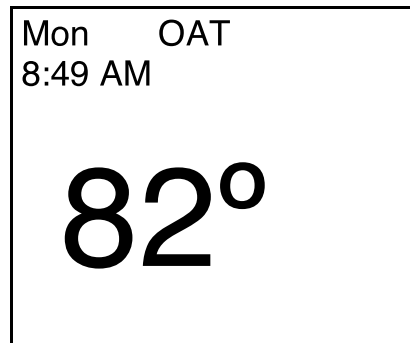

Fig. 10 — OAT Display Screen

If there is additional data at the end or beginning of a table or list that is not on the screen, the cursor will not advance move down past the next-to-last line or up past the second line on the screen.

Linkage Coordinator Zone Controller Bus Scan — Pressing PAGE UP/PAGE DOWN together for 3 seconds from the Default screen of a Linkage Coordinator Zone Controller Default screen will display the Bus Scan screen. Bus Scan allows the user to scan through the linkage coordinator’s zones and display what is found at each address. Refer to Bus Scan section on page 11 for additional information on Linkage Coordinator Zone Controller Bus Scan.

INC/DEC — The INC and DEC buttons modify the value of the highlighted field within its defined limits. For discrete decisions (Example, No/Yes), the INC/DEC buttons toggle between the two values. For decisions with a few distinct values instead of a range (for example, baud rate and day of week), the INC/DEC buttons scroll through the available values. For text decisions, the INC/DEC buttons modify one character at a time, scrolling through the appropriate range of ASCII characters.

From the Zone Controller Default screen, the INC/DEC buttons allow the user to modify the set points. Pressing the INC/DEC buttons continuously updates the highlighted field and the rate of change accelerates over time.

NAVIGATE — This rotary knob functions like the SCROLL UP/DOWN buttons, with the same sort of wrap-around. However, it also incorporates a left-right movement. The cursor moves one selectable field with each increment of the rotary knob. Turning the knob clockwise moves the cursor to the right and down. With each increment, the cursor advances to the next field to the right on the current line. If the cursor is on the last field in the line, the cursor advances to the first (left-most) field in the next line. Turning the knob counterclockwise moves the cursor to the left and up in the same manner.

NOTE: For strings truncated for display, NAVIGATE will adjust a sliding window of as many characters as can fit on the line. The NAVIGATE rotary knob also functions as the EXIT button when pressed.

EXIT — The EXIT button returns the display to the next higher screen in the hierarchy. If the EXIT button is pressed and the data on the screen cannot be or has not been modified, the

System Pilot moves to the next higher screen immediately (no additional prompts).

MODIFY — Like the INC/DEC buttons, this rotary knob modifies the value of the highlighted field within its defined limits. The value increases or decreases with each increment of the rotary knob. Turning the knob clockwise increases the value. Turning it counterclockwise decreases it. For discrete decisions (No/Yes for example), the MODIFY knob toggles between the two values. For decisions with a few distinct values instead of a range (baud rate and day of week), the MODIFY knob scrolls through the available values. For text decisions, the MODIFY knob changes one character at a time, scrolling through the appropriate range of ASCII characters. From the Zone Controller Default screen, the MODIFY knob allows the user to modify the set points.

The MODIFY rotary knob also functions as the SELECT button when pressed.

SELECT — This button function varies according to the screen that is currently displayed and the device to which the System Pilot is attached. In general, the SELECT button processes a user-selected option or initiates a new operation mode for the System Pilot.

Zone Controller Occupancy Override — Pressing the SELECT button for less than 3 seconds from the Zone Controller Default screen while in an unoccupied mode, will initiate an occupancy override. While the occupancy status is blinking, the user can use the INC/DEC buttons or the MODIFY rotary knob to adjust the occupancy status.

System Pilot Alternate Maintenance Table — Pressing the SELECT button for at least 3 seconds from the Zone Controller Default screen will display the System Pilot Alternate Maintenance Table (ALT_DISP).

Edit Mode — If the System Pilot is displaying editable data, SELECT allows the user to MODIFY the point that the cursor is positioned on.

Force/Auto — If the System Pilot is displaying a status display or maintenance table and if the point that the cursor is positioned on is forcible, pressing SELECT initiates the Force/Auto function. The System Pilot message line will display “Force:” followed by three softkeys. The first softkey shows the point value and the other two softkeys are AUTO and ESC (Escape).

The NAVIGATE rotary knob can be used to move between the softkeys (with wraparound). While the cursor is on the value softkey, the value can be modified (forced) using the INC/DEC pushbuttons or the MODIFY rotary knob. Pressing SELECT writes the new force value to the point, erases the message line, and returns the user to the status display or maintenance table.

Positioning the cursor on AUTO and pressing SELECT removes the force from the point, erases the message line prompt and returns to the current screen.

Positioning the cursor on ESC and pressing SELECT erases the message line prompt and returns to the current screen without affecting the point. Pressing the EXIT button erases the prompt and returns to the current screen without affecting the point.

If the EXIT button is pressed and the data on the screen has been modified, the System Pilot displays the prompt “Save data?” followed by the following softkeys: YES, NO and ESC. The NAVIGATE rotary knob can be used to move between YES, NO, and ESC (with wraparound). Position the cursor on the desired softkey and press SELECT. Selecting YES causes the System Pilot to write the new data to the controller and then return to the next higher screen. Selecting NO returns the System Pilot to the next higher screen without saving the new data. Pressing Selecting ESCAPE or pressing the EXIT button erases the “Save data?” prompt and causes the System Pilot to remain in the current screen.

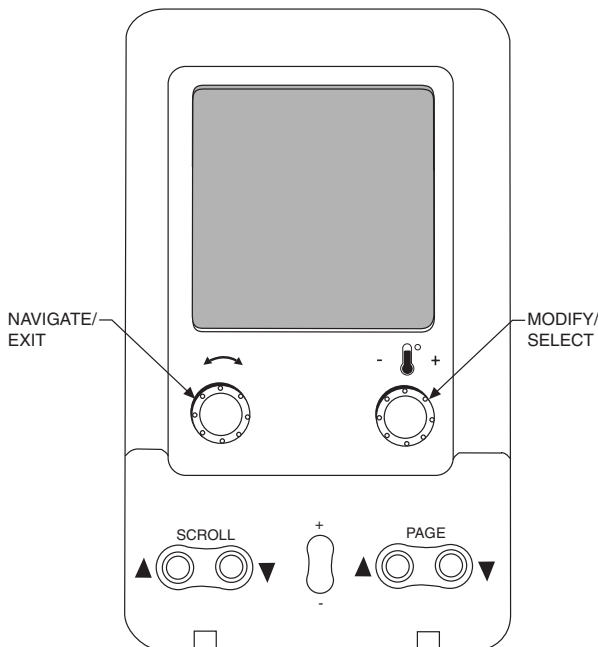

Fig. 11 — System Pilot User Interface

→ **Attach Screen Navigation** — Pressing SCROLL UP and PAGE DOWN together for 3 seconds from any screen will display the Attach screen. If the data on the current screen has been modified, the user will be prompted to save the data as described above. Exiting from the Attach screen without attaching will cause the System Pilot to display the Program screen (not the screen from which the buttons were pushed).

Timeout Feature — If no user input is received for an hour (i.e., if no buttons are pressed and no rotary knobs are turned), the System Pilot reverts to the Default screen for its default device. If connected to another device, the System Pilot will re-attach to the default device.

Program Mode — To enter Program mode and display the Program screen, press the SCROLL UP and SCROLL DOWN buttons together for 3 seconds from the default screen. The System Pilot will display one of the four program screens shown in Fig. 12, depending on the security level that is specified in the System Pilot (PILOTCON) screen.

Use the SCROLL UP/SCROLL DOWN buttons or the NAVIGATE knob to step through the options on the Program screen. A description of the highlighted option will appear in the bottom line of the screen and will indicate if the option is not available. Press the SELECT button to select the currently highlighted option.

The following program screen options are available:

- ATTACH
- Ctr-ID
- ALARM HIST
- TIME/DATE
- CONFIG
- MAINT
- SERVICE
- SETPOINTS
- SCHEDULES
- STATUS
- SETUP
- DETACH

ATTACH — Selecting the ATTACH option from the Program screen displays one of the Attach screens shown in Fig. 13 and 14, according to whether the System Pilot is on the Carrier communicating network or on the local bus.

The center portion of the screen shows the 8-character controller name, bus number and element number for the devices to which the System Pilot can attach. The first entry in the list always displays the default device and shows “Default” instead of the actual controller name.

The user can use the SCROLL UP/DOWN, NAVIGATE, or PAGE UP/PAGE DOWN buttons to scroll through the list of devices. To modify an existing bus and element number field, press SELECT, then use INC/DEC or MODIFY to modify the field, then press SELECT again to attach.

If the System Pilot is already attached to the specified address, the System Pilot will display the message “Reattach?” followed by three softkeys displaying YES, NO, and ESC. Use the NAVIGATE rotary knob to move between the softkeys and press SELECT. The user can also press EXIT to erase the prompt and remain in the Attach screen.

→ **CLEAR LIST** — If the System Pilot is on the Carrier communicating network, the last line of the attach list will have a “Clear list” prompt instead of a controller name and address. The user can position the cursor on this line and press SELECT to reinitialize the attach list. When this line is selected, the System Pilot will display the message “Clear attach list?” followed by two softkeys displaying YES and NO. Use the NAVIGATE rotary knob to move between the softkeys and press SELECT. Selecting YES causes the System Pilot to delete all controller data from the attach list. Selecting NO or pressing EXIT erases the prompt and leaves the attach list as is. Note that the Clear List feature does not affect the first line of the attach list, which always displays the default device.

→ **CLEAR LINE** — If the System Pilot is on the Carrier communicating network, the user can clear a single line in the attach list by positioning the cursor on the line and pressing SELECT for more than 3 seconds. After deleting the controller data from the line, the System Pilot will position the cursor on

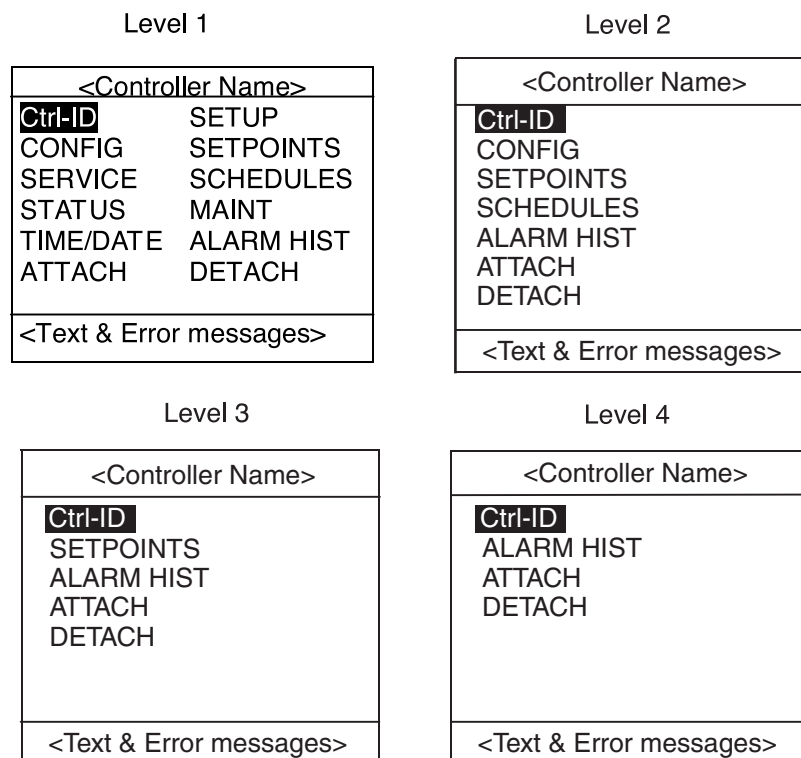

→ **Fig. 12 — Program Screens**

the element number and allow the user to edit the entry (as described above). Note that the Clear Line feature does not apply to the first line of the attach list, which always displays the default device.

ATTACHING TO AN UNADDRESSED ZONE CONTROLLER — If the System Pilot attaches to an un-addressed VVT® Zone Controller (connected to the local COMM2 port), it will display the Zone Controller's Ctlr-ID screen as a prompt for the user to set the Zone Controller's address. This screen will show the controller element number as 0, even though the controller will actually be at its default element number of 140. Use the instructions in the Ctlr-ID section below to set the address before exiting from this screen. When the System Pilot attaches to an addressed Zone Controller, the System Pilot will bring up the standard Zone Controller Default screen.

CTRL-ID — Selecting the Ctlr-ID option from the Program screen displays the Controller ID screen shown in Fig. 15.

The center portion of the screen shows the following information for the controller to which the System Pilot is currently attached. The controller name, device description, software part number, reference number, element number, bus number and baud rate are shown. The device description and reference number will be truncated, if necessary, to fit on the screen. The controller name, device description, address and baud rate are modifiable.

→ Use the SCROLL UP/DOWN buttons or the NAVIGATE knob to scroll through the screen data. Press the SELECT button to modify the highlighted line. For Bus Number, Element Number, and Baud Rate, use the INC/DEC buttons or the MODIFY rotary knob to adjust the highlighted value. For the controller name and device description, the System Pilot will highlight the first ASCII character. Use the NAVIGATE knob to move to the left or right within the field. Use INC/DEC or the MODIFY rotary knob to adjust the highlighted character. Pressing the EXIT button causes the System Pilot to return to the Program screen. If the controller name, bus number, or element number were modified, then the System Pilot will update the corresponding attach list entry with the new data.

ALARM HIST — Selecting the ALARM HIST option from the Program screen displays the Alarm History screen. See Fig. 16. This screen shows the most recent alarms and alerts generated by the attached device and stored in its Alarm History table.

The top line shows the 8-character device name. The middle of the screen shows the alarms/alerts, displayed one at a time. The bottom line shows the current alarm number and the number of alarms in the table. This line may also display error messages as applicable.

Use the SCROLL UP/DOWN or PAGE UP/DOWN buttons or the NAVIGATE knob to scroll through the alarms/alerts one at a time. If the EXIT button is pressed, the System Pilot will return to the Program screen.

TIME/DATE — Selecting the TIME/DATE option from the Program screen displays the Time and Date screen shown in Fig. 17. This screen shows the day-of-week, time, holiday flag and date of the attached device.

The top line shows the 8-character device name. The bottom line shows any text and error messages, as applicable. All of the fields in the center portion of the screen (Day of Week, Time, etc.) can be modified.

Use the SCROLL UP/DOWN buttons or the NAVIGATE knob to scroll through the screen one line at a time. Press the SELECT button to modify the highlighted line. Use the INC/DEC buttons or the MODIFY rotary knob to adjust the highlighted value. Pressing the EXIT button causes the System Pilot to return to the Program screen.

Attach to Controller		
Name	Bus#	Element#
Default	0	12
CTRL1	1	7
CTRL2	10	16
CTRL3	0	125
	0	0
	0	0
<Text & Error messages>		

Fig. 13 — Attach Screen (System Pilot on Carrier Communicating Network)

Attach to Controller		
Name	Bus#	Element#
Default	0	12
SYSPILOT	0	235
<Text & Error messages>		

Fig. 14 — Attach Screen (System Pilot on Local Bus)

Controller ID	
CTRLNAME	
Generic controller	
CESR123456-99	
Version 7.89	
Bus Number	0
Element Number	123
Baud Rate	9600
< Text & Error messages >	

Fig. 15 — Controller ID Screen

<Controller Name>
Alarm6 14:30 04/23/03
Communication failure - Zone Controller 141
Alarm 1 of 10

Fig. 16 — Alarm History Screen

→ CONFIG, MAINT, SERVICE, SET POINTS, OR STATUS TABLES — If one of the table options (CONFIG, MAINT, SERVICE, SETPOINTS or STATUS) is selected from the Program screen, and if there is more than one entry in the corresponding table list, then the System Pilot displays a Table List screen as shown in Fig. 18. If there is only a single table, the System Pilot displays the contents of the table.

The top line of the Table List screen shows the table type that was selected. The bottom line shows text and error messages, as applicable. The center portion of the screen shows the table list. This consists of the table names from the specified list, arranged in alphabetical order. If the list has more than 7 tables, then the first 7 tables will be displayed.

Use the SCROLL UP/DOWN buttons or the NAVIGATE knob to scroll through the list. If there are more than 7 tables, pressing PAGE UP/DOWN will display the previous or next 7 names from the list. Press the SELECT button to display the highlighted line.

If a table type with multiple table entries was selected, the System Pilot will display a Multiple Table List screen with all of the table names associated with that table type.

If it is a table type with a single table entry, the System Pilot will display a Standard Table screen.

Multiple Table List Screen — If multiple tables of a selected type are available, or if SCHEDULE is selected from the Program screen and there are multiple schedules, the System Pilot will display a Multiple Table List screen with all of the table names associated with that table type.

The top line shows the name of the table that was selected. The bottom line shows text and error messages, as applicable. The center portion of the screen lists the associated tables in alphabetical order. If the list has more than 7 tables, then the first 7 tables will be displayed.

Use the SCROLL UP/DOWN buttons or the NAVIGATE knob to scroll through the list. If there are more than 7 tables, pressing PAGE UP/DOWN will display the previous or next 7 names from the list. Press the SELECT button to read the

highlighted table from the attached device and display an appropriate screen. A Time Schedule screen is displayed if the table is a time schedule, or a Standard Table screen is displayed for any other table. Pressing the EXIT button causes the System Pilot to return to the Table List screen.

→ **Standard Table Screen** — If a table type with a single table entry is selected from a Table List screen, or a table (other than a schedule) is selected from a Multiple Table List screen, the System Pilot displays a Standard Table screen.

The top line shows the 8-character table name. The center portion of the screen shows the table data. Dynamic table data (display and maintenance) is read from the attached device and updated on the screen every 15 seconds. If a read attempt (one try plus three retries) fails, the System Pilot will display “C” (gray background) after the point name in each data line. An error message is displayed on the bottom line (“Communication failure”). If the EXIT button is pressed, the System Pilot returns to the next higher screen.

Static table data (configuration, set points and service configuration) is read from the attached device once, when the table is first selected and displayed. There will be one point/decision per line. If there are more than seven decisions/points, the first seven will be displayed initially. The bottom line displays text and error messages, as applicable.

Use the SCROLL UP/DOWN buttons or the NAVIGATE knob to scroll through the data. If there are more than 7 decisions/points, pressing PAGE UP/DOWN will display the previous or next 7 decisions/points. As the user scrolls through the table, the System Pilot will highlight the current decision/point and if there is an associated point name, the 24-character descriptor will be displayed on the bottom line. If there is no associated point name, the System Pilot will display the 24-character descriptor in the center portion of the screen.

The operation of the SELECT button varies, depending on whether the user is viewing dynamic or static table data. For dynamic table data, if the SELECT button is pressed and the current point is forcible, the System Pilot will force or auto the point. If the current value is not forcible, the System Pilot will ignore the SELECT button.

For static table data, if the SELECT button is pressed and the current point is editable, the System Pilot allows the user to modify the point.

NOTE: For strings truncated for display, NAVIGATE will adjust a sliding window of as many characters as can fit on the line.

For ASCII decisions with a list-selectable value, the System Pilot will display a Configuration List screen with the available values. If the current decision has a list-selectable value but the System Pilot is unable to obtain the list, it will display an appropriate error message. Pressing the EXIT button causes the System Pilot to return to the next higher screen.

Configuration List Screen — If the user presses the SELECT button while the System Pilot is displaying static table data (for example, a configuration table) and the current decision has a list-selectable value, the System Pilot will display a Configuration List screen. This type of screen will be displayed for certain configuration decisions in the Universal Controller and the Zone Controller as well as for certain decisions in the System Pilot’s REMOTE table.

The top line shows the decision’s 24-character descriptor, truncated if necessary. The bottom line displays error messages, if applicable. The center portion of the screen shows the available values (text strings) for the decision. There will be one text string per line, truncated if necessary.

Use the SCROLL UP/DOWN buttons or the NAVIGATE knob to scroll through the list. If there are more than 7 text strings in the list, pressing PAGE UP/DOWN will display the previous or next 7 text strings from the list. If the SELECT

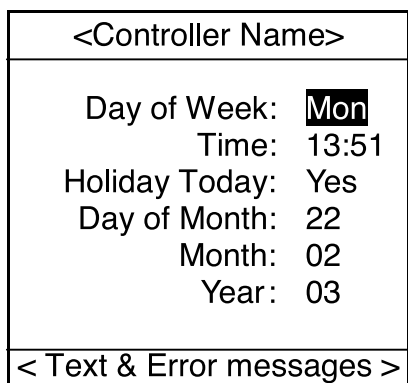

Fig. 17 — Time and Date Screen

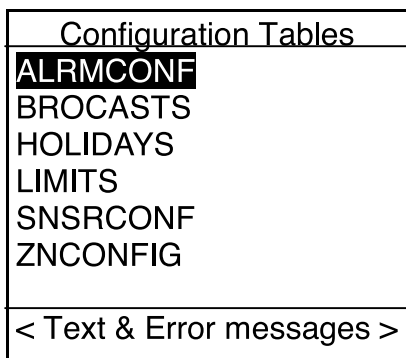

Fig. 18 — Table List Screen

button is pressed, the System Pilot will return to the Standard Table screen and will show the selected text string as the current decision value. The System Pilot will display the decision value as text; however, it stores the value in the table according to the decision's data type and limits. Pressing the EXIT button will cause the System Pilot to return to the Standard Table screen without updating the current decision.

SCHEDULE — Selecting the SCHEDULE option from the Program screen and then selecting a Time Schedule table displays the Time Schedule screen as shown in Fig. 19. This example shows all 8 of the time schedule periods, even though only the first 6 (plus the header line) will actually be shown on the System Pilot when this screen is entered.

The top line shows the 8-character schedule name. The bottom line displays text and error messages, if applicable. The center portion of the screen shows the schedule data which are the occupied and unoccupied times for each period and the days to which the period applies. The time is displayed with a 24-hour clock with colon (00:00 to 24:00). The day flags are displayed as 8 bits (0 or 1), for Monday through Sunday plus holiday. The times and day flags are modifiable. The period numbers and the header line are fixed. Each of the day flags is treated as a separate field, therefore, there are 12 modifiable fields per line.

Use the SCROLL UP/DOWN buttons or the NAVIGATE knob to scroll through the table one line at a time. If the SELECT button is pressed, the System Pilot allows the user to modify the data on the current line (starting with Occupied hour). Use the NAVIGATE knob to move within the line. As each field is highlighted, the truncated 24-character descriptor is displayed on the message line. Use the INC/DEC buttons or the MODIFY rotary knob to adjust the highlighted value. If the EXIT button is pressed, the System Pilot will return to the Program screen or the Multiple Table List screen.

SETUP — Selecting the SETUP option from the System Pilot's Program screen allows the user to access a special time saving feature for Universal Controller configuration. This feature helps expedite the configuration process by presenting a controller-specific menu that guides the user through the controller's setup procedure.

NOTE: This option only applies when the System Pilot is in communication with a Universal Controller.

→ **DETACH** — Select this option from the Program screen to disconnect from the device to which the System Pilot is currently attached. The System Pilot will attach to itself and display the System Pilot default screen.

Modifying Set Points — The VVT® zone controller default screen displays two set points. The Remote Attach Default screen will display up to two set points. The user can modify the displayed set points by turning the MODIFY rotary

knob or pressing the INC/DEC buttons. The displayed set points will blink.

The System Pilot will modify a set point subject to the limits read from the controller. If there are two set points, the System Pilot will modify them simultaneously and will preserve the difference between them subject to the limits read from the controller.

The System Pilot has configurable high and low limits for set points, as defined in the System Pilot Configuration Table and the System Pilot remote attach configuration table. On a Remote Attach Default screen, the limits will be applicable to the set points if the set point units are degrees, otherwise, they will be ignored.

The System Pilot's internal limits will not affect the display. The System Pilot reads the set points from the device and displays them as read, even if they are outside the configured System Pilot limits.

→ Pressing SELECT while a set point is blinking sends the new set point to the controller. Before sending the new set point to the device, the System Pilot will clamp the set point to its own internal limits and will display the clamped set point on the screen. If clamping a set point results in a value that is outside the limits read from the device, the System Pilot will display an error indication ("LIMIT") and will not write the set point to the device.

Pressing EXIT while a set point is blinking will cause the System Pilot to revert to the original set point. Changing the set point without pressing SELECT or EXIT for 15 seconds will also cause the System Pilot to write the new set point to the controller.

The System Pilot will not write set points to the controller unless they have been changed from their original values.

Occupancy Override — To initiate an override from the Zone Controller Default Screen (if the Zone Controller's occupancy status is UNOC), press the SELECT button for less than 3 seconds. The occupancy status will begin to blink. While the occupancy status is blinking, use the INC/DEC buttons or the MODIFY rotary knob to adjust the occupancy status. If the occupancy status is changed to OCC and then SELECT is pressed, the System Pilot sends the occupancy override to the Zone Controller.

If the occupancy status has been changed and the user does not press SELECT or EXIT within 15 seconds, the System Pilot will send the occupancy override to the controller and the occupancy status will stop blinking. If the occupancy status has not been changed, the System Pilot will not send occupancy status.

If the user presses EXIT while the occupancy status is blinking, the System Pilot will revert to the UNOC status. The System Pilot will not change the Zone Controller's occupancy status.

If communication to the Zone Controller fails, the System Pilot will display "COMFAIL" on the bottom line for 5 seconds.

NOTE: An occupancy override from the System Pilot will be summed into the Tenant Billing Option's accumulation of override times.

OCCPC01S			
Per	Occ	Unoc	DOW
1	07:00	08:00	0111 1000
2	08:00	17:00	0111 1100
3	09:00	15:00	10000011
4	00:00	00:00	00000000
5	00:00	00:00	00000000
6	00:00	00:00	00000000
7	00:00	00:00	00000000
8	00:00	00:00	00000000
< Text & Error messages >			

Fig. 19 — Time Schedule Screen

Alternate Maintenance Table — To display the System Pilot Alternate Maintenance Table (ALT_DISP), press the SELECT button for at least 3 seconds from the Zone Controller Default Screen. The System Pilot will display the Linkage Controller or zone controller Alternate Maintenance Table shown in Fig. 20, depending on whether or not the attached Zone Controller has been designated as a Linkage Coordinator (in the Zone Controller’s Linkage Configuration [LINKAGE] Table).

If the Zone Controller is not a Linkage Coordinator, the ALT_DISP table will simply display the zone controller’s Points Display Table (POINTS) values. If the Zone Controller is a Linkage Coordinator, the ALT_DISP table will display the zone controller’s Points Display Table values followed by the Master Zone Maintenance Table (MZNMAINT) values.

NOTE: The user will not be able to force any values from this table regardless of whether the same point is forcible from any other table.

Use the SCROLL UP/DOWN, NAVIGATE, or PAGE UP/PAGE DOWN buttons to scroll through the table. Pressing the EXIT button causes the System Pilot to return to the Zone Controller Default screen.

Bus Scan — If the PAGE UP and PAGE DOWN buttons are pressed at the same time for 3 seconds and if the attached device is a Linkage Coordinator, then the System Pilot will display the Bus Scan screen. See Fig. 21.

NOTE: If the attached device is not a Linkage Coordinator, the System Pilot will ignore this button combination.

Approximately every sixty seconds, the Linkage Coordinator attempts to communicate with its associated Zone Controllers, optional Bypass Controller, and optional Air Source. The status of this communication attempt is shown in the Bus Scan screen.

The top line shows the title “3V Bus Scan: NNN,” where NNN is the bus number of the attached device. The next line is the data header, which is shaded gray. The rest of the screen shows the following data from the scanned devices: device address (Addr), device type (DevType), alarm flag (Alm) and status (Stat).

The alarm flag will be Yes if there are outstanding alarms in the device’s alarm history table and No otherwise. The status column will display Zone Controller’s space temperature, Bypass Controller’s duct temperature, or “Fail” if the Linkage Coordinator is unable to communicate with the device. The alarm flag and status will be dashes (“----”) for non-3V devices. Temperatures will be displayed with one decimal place. Values of -40.0 and 245.0 F will be displayed for open and shorted sensors.

Use the SCROLL UP/DOWN, NAVIGATE or PAGE UP/PAGE DOWN buttons to scroll through the list of devices. Pressing the EXIT button causes the System Pilot to return to the Master Zone Controller (Linkage Coordinator) Default screen.

Zone Controller

ALT_DISP	
MODE	VENT
TYPE	SNGLDUCT
CNTSP	78.0°F
SPT *	11.0°F
DMPPOS	50% OPE
SAT	0.0°F

Terminal Mode

Linkage Coordinator

ALT_DISP	
NEXTMODE	VENT
LINKMODE	HEAT
AIRSOURCE	YES
BYPASS	YES
REF_DMD	15.0°F
REF_ZONE	4

Desired System Mode

3V Bus Scan: 123			
Addr	DevType	Alm	Stat
129	Bypass	No	72.6
128	Master	Yes	72.3
127	Zone	No	Fail
126	Zone	No	-40.0
125	Zone	Yes	73.1
124	Other	----	----

<Text & Error messages>

Fig. 21 — 3V™ Bus Scan Screen

CONFIGURATION TABLES

System Pilot operation is controlled by decisions entered in a group of configuration tables. The System Pilot contains the following configuration tables:

- ALARMDEF — Alarm Configuration Table
- BRODEF — Broadcast Configuration Table
- HOLDYXXS — Holiday Configuration Table
- REMOTE — Remote Attach Configuration Table
- PILOTCON — System Pilot Configuration Table

Alarm Configuration (ALARMDEF) Table — The Alarm Configuration table is shown in Table 3.

RE-ALARM TIME — This decision is used to configure the number of minutes the System Pilot will wait before an alarm condition that has not been corrected will be re-transmitted on the Carrier communicating network. Re-alarms of an alarm condition will continue until the condition no longer exists.

Re-Alarm Time: Allowable Entries 0 = Disabled
1 to 1440 min
Default Value 0 min

ALARM ROUTING — This decision is used to indicate which Carrier communicating network element will receive and process alarms sent by the System Pilot. This decision consists of eight digits. Each digit represents a network device and can be set to a zero or one. A setting of 1 indicates that alarms should be processed by this device. A setting of 0 indicates that the device should ignore alarms from the System Pilot. Currently the digits correspond to the following devices: first (left most) digit - user interface software; second digit - Autodial Gateway or TeLink; fourth digit - Alarm Printer Interface Module/DataLINK/BAClink/Carrier Translator; digits 3, and 5 through 8 - unused.

Alarm Routing: Allowable Entries 0 - 1 (each position)
Default Value 00000000

Broadcast Configuration (BRODEF) Table — The Broadcast Configuration table is shown in Table 4.

TIME BROADCAST ENABLE — This decision is used to indicate whether the System Pilot will broadcast the time, date and holiday status to other system elements on the Carrier communicating network. The broadcast will occur at 1:00 AM, 1:00 PM, when a request for time is received from the CCN, and when the time or date is changed.

Time Broadcast Enable: Allowable Entries Disable / Enable
Default Value Disable

DAYLIGHT SAVINGS — The Daylight Savings point gives the user the capability to broadcast the current time on the Carrier communicating network and configure the start and end of daylight saving time.

Start Month — Use this decision to enter the month in which the real time clock will adjust the time for the start of daylight saving time.

Start Month: Allowable Entries 1 to 12
Default Value 4

Start Day of Week — Use this decision to enter the day of the week on which the real time clock will adjust the time for the start of daylight saving time.

Start Day of Week: Allowable Entries 1 to 7
Default Value 7

Start Week — Use this decision to enter the week of the month in which the real time clock will adjust the time for the start of daylight saving time.

Start Week: Allowable Entries 1 to 5
Default Value 1

Start Time — Use this decision to enter the time of day at which the real time clock will adjust the time for the start of daylight saving time.

Start Time: Allowable Entries 0:00 to 24:00
Default Value 2:00

Start Advance — Use this decision to enter the number of minutes by which the real time clock will adjust the time for the start of daylight saving time. An entry of 0 will disable this feature.

Start Advance: Allowable Entries 0 to 360 min
Default Value 60 min

Stop Month — Use this decision to enter the month in which the real time clock will adjust the time for the end of daylight saving time.

Stop Month: Allowable Entries 1 to 12
Default Value 10

Stop Day of Week — Use this decision to enter the day of the week on which the real time clock will adjust the time for the end of daylight saving time.

Stop Day of Week: Allowable Entries 1 to 7
Default Value 7

Table 3 — Alarm Configuration (ALARMDEF)

DESCRIPTION	DISPLAY	POINT	RANGE	DEFAULT
Alarm Configuration				
Re-alarm Time	xxx min	RETIME	0-1440	0
Alarm Routing	xxxxxxxx*	ROUTING	0-11111111	00000000

*This is an 8-bit binary value, where each digit is 0 or 1.

Table 4 — Broadcast Configuration (BRODEF)

DESCRIPTION	DISPLAY	POINT	RANGE	DEFAULT
Real Time Clock				
Time Broadcast Enable	Disable/Enable	TIMEBCST	0-1	Disable
Daylight Savings		DAYSAV		
Start Month	XX	DLSTRMON	1-12	4
Start Day of Week	X	DLSTRDOW	1-7	7
Start Week	X	DLSTRWK	1-5	1
Start Time	XX:XX	DLSTRTIM	0:00-24:00	2:00
Start Advance	XXX min	DLSTRADV	0-360	60
Stop Month	XX	DLSTPMON	1-12	10
Stop Day of Week	X	DLSTPDOW	1-7	7
Stop Week	X	DLSTPWK	1-5	5
Stop Time	XX:XX	DLSTPTIM	0:00-24:00	2:00
Stop Back	XXX min	DLSTPADV	0-360	60

Stop Week — Use this decision to enter the week of the month in which the real time clock will adjust the time for the end of daylight saving time.

Stop Week: Allowable Entries 1 to 5
 Default Value 5

Stop Time — Use this decision to enter the time of day at which the real time clock will adjust the time for the end of daylight saving time.

Stop Time: Allowable Entries 0:00 to 24:00
 Default Value 2:00

Stop Back — Use this decision to enter the number of minutes by which the real time clock will adjust the time for the end of daylight saving time. An entry of 0 will disable this feature.

Stop Back: Allowable Entries 0 to 360 min
 Default Value 60 min

Holiday (HOLDYxxS) Configuration Table — The Holiday Configuration Table is shown in Table 5. Up to 30 Holiday tables (HOLDY01S – HOLDY30S) may be configured. An explanation of each configuration decision follows.

START MONTH — Use this decision to indicate the month of the year in which the holiday will begin.

Start Month: Allowable Entries 1 to 12
 Default Value 1

START DAY — Use this decision to indicate the day of the month on which the holiday will begin.

Start Day: Allowable Entries 1 to 31
 Default Value 1

DURATION — Use this decision to indicate the number of consecutive days that the holiday will last. If you enter 0 in this decision, the holiday schedule will be disabled.

Duration: Allowable Entries 0 = Disable or 1 to 365
 Default Value 0

Remote Attach Configuration (REMOTE)

Table — The Remote Attach Configuration Table is shown in Table 6. An explanation of each configuration decision follows.

REMOTE ATTACH ENABLE — Use this decision to enable the Remote Attach function. This function allows the System Pilot to perform the following operations for a specified device referred to as the “remote device.” This functionality occurs as a background task to the System Pilot’s normal functionality.

- write space temperature
- compute an operating mode
- monitor and modify set points

While the Remote Attach function is enabled, the System Pilot can attach to (using the Program screen Attach option) and communicate with the remote device or any other device. The Remote Attach will remain in effect until it is disabled.

NOTE: If Remote Attach is being used with a VVT® zone controller, the System Pilot will write its space temperature to the Zone Controller, but will not perform the set point monitoring/control or mode calculation. Set point monitoring/control and mode calculation is performed for the Zone Controller from the Zone Controller Default Screen.

Remote Attach: Allowable Entries Disable / Enable
 Default Value Disable

REMOTE DEVICE BUS NUMBER — Use this decision to configure the bus number of the remote device. The remote device can be on any Carrier communicating network bus.

Remote Device Bus Number: Allowable Entries 0 to 239
 Default Value 0

ELEMENT NUMBER — Use this decision to configure the element number of the remote device. Element Number must be non-zero and Remote Attach Enable must be set to Enable for the remote attach function be used.

Element Number: Allowable Entries 0 to 239
 Default Value 0

Table 5 — Holiday Configuration (HOLDYXXS)

DESCRIPTION	DISPLAY	POINT	RANGE	DEFAULT
Start Month	XX	MONTH	1-12	1
Start Day	XX	DAY	1-31	1
Duration	XXX	DURATION	0-365	0

→ **Table 6 — Remote Attach Configuration (REMOTE)**

DESCRIPTION	DISPLAY	POINT	RANGE	DEFAULT
Remote Attach				
ALL DEVICES				
Remote Attach Enable	Disable/Enable	R_ATTACH	0-1	Disable
Remote Device				
Bus Number	XXX	REMBUSNO	0-239	0
Element Number	XXX	REMELENO	0-239	0
Space Temp Variable	XXXXXXXX*	REMSPT	ASCII*	SPT
Write SPT to Remote	No/Yes	REMWRITE	0-1	Yes
NON-3V ONLY:				
Cool Setpoint				
Table Name	XXXXXXXX	CSP_TAB	ASCII*	(blank)
Setpoint Name	XXXXXXXX	CSP_NAME	ASCII	(blank)
Low Limit	xxx.x dF	CSP_LLIM	-40-245	-40
High Limit	xxx.x dF	CSP_HLIM	-40-245	245
Heat Setpoint				
Table Name	XXXXXXXX	HSP_TAB	ASCII*	(blank)
Setpoint Name	XXXXXXXX	HSP_NAME	ASCII	(blank)
Low Limit	xxx.x dF	HSP_LLIM	-40-245	-40
High Limit	xxx.x dF	HSP_HLIM	-40-245	245
Mode Calculation	Disable/Enable	MODECALC	0-1	Disable
Supply Temp Variable	XXXXXXXX	SAT_VAR	ASCII*	SAT
Fan Status Variable	XXXXXXXX	SFS_VAR	ASCII*	SFS

*ASCII range limited to A-Z, 0-9, underscore, dash.

SPACE TEMP VARIABLE — Use this decision to supply the name of the Carrier communicating network space temperature variable to be written to by the System Pilot. Space temperature will be written to the remote device once a minute or whenever the value changes by 0.3° F.

Space Temp Variable: Allowable Entries Up to 8 characters - upper case letters, numbers, -, or _
Default Value SPT

→ WRITE SPT TO REMOTE — Use this decision to cause the System Pilot to write its space temperature to the specified Space Temp Variable in the remote device. If the Remote Attach function is enabled and Write SPT to Remote is set to Yes, the System Pilot will write the space temperature once a minute or whenever the value changes by 0.3 F. The System Pilot will perform this function regardless of the device to which the System Pilot is attached. If a Remote Attach is disabled or if Write SPT to Remote is changed to No, the System Pilot will auto the space temperature variable in the remote device, allowing the variable to return to its own value.

If Write SPT to Remote is set to Yes and the space temperature sensor in the System Pilot fails, then the System Pilot will auto the space temperature variable in the remote device and issue an alarm message. The System Pilot will issue a return to normal and resume writing SPT to the remote device when the sensor returns to normal.

Write SPT to Remote: Allowable Entries No / Yes
Default Value Yes

SET POINT MODIFICATION (NON-3V ONLY) — The System Pilot can monitor and/or modify up to two set points in the specified device from the Remote Attach Default Screen. The set point(s) must be in a set point table. The two set points do not have to be in the same set point table.

The System Pilot reads the set points once per minute and updates them upon user request from the Remote Attach Default Screen.

Cool Set Point Table Name — Use this decision to specify the Table Name containing the Cool Set Point to be monitored and/or updated by the System Pilot.

Cool Set Point Table Name: Allowable Entries Up to 8 characters - upper case letters, numbers, -, or _
Default Value (blank)

Cool Set Point Name — Use this decision to specify the point name of the Cool Set Point to be monitored and/or updated by the System Pilot.

Cool Set Point Name: Allowable Entries Up to 8 characters - upper case letters, numbers, -, or _
Default Value (blank)

Cool Set Point Low Limit — Use this decision to specify the lowest value that can be sent to the cool set point specified by the Table Name and Set Point Name. If the value being sent is below this limit, the System Pilot will clamp the value to this limit before sending it to the device.

This limit will not affect the set point display. The System Pilot will read the set point from the device and display it as read, even if outside the high and low limits. Also, this limit will only apply if the set point units are degrees F or C.

If clamping the set point results in a value that is outside the configuration limits read from the device, the System Pilot will display an error indication (“LIMIT”) and will not write the set point to the device.

Cool Set Point Low Limit: Allowable Entries -40 to 245 F
Default Value -40 F

Cool Set Point High Limit — Use this decision to specify the highest value that can be sent to the cool set point specified by the Table Name and Set Point Name. If the value being sent is above this limit, the System Pilot will clamp the value to this limit before sending it to the device.

This limit will not affect the set point display. The System Pilot will read the set point from the device and display it as read, even if outside the high and low limits. Also, this limit will only apply if the set point units are degrees F or C.

If clamping the set point results in a value that is outside the configuration limits read from the device, the System Pilot will display an error indication (“LIMIT”) and will not write the set point to the device.

Cool Set Point High Limit: Allowable Entries -40 to 245 F
Default Value 245 F

Heat Set Point Table Name — Use this decision to specify the Table Name containing the Heat Set Point to be monitored and/or updated by the System Pilot.

Heat Set Point Table Name: Allowable Entries Up to 8 characters - upper case letters, numbers, -, or _
Default Value (blank)

Heat Set Point Name — Use this decision to specify the point name of the Heat Set Point to be monitored and/or updated by the System Pilot.

Heat Set Point Name: Allowable Entries Up to 8 characters - upper case letters, numbers, -, or _
Default Value (blank)

Heat Set Point Low Limit — Use this decision to specify the lowest value that can be sent to the heat set point specified by the Table Name and Set Point Name. If the value being sent is below this limit, the System Pilot will clamp the value to this limit before sending it to the device.

This limit will not affect the set point display. The System Pilot will read the set point from the device and display it as read, even if outside the high and low limits. Also, this limit will only apply if the set point units are degrees F or C.

If clamping the set point results in a value that is outside the configuration limits read from the device, the System Pilot will display an error indication (“LIMIT”) and will not write the set point to the device.

Heat Set Point Low Limit: Allowable Entries -40 to 245 F
Default Value -40 F

Heat Set Point High Limit — Use this decision to specify the highest value that can be sent to the heat set point specified by the Table Name and Set Point Name. If the value being sent is above this limit, the System Pilot will clamp the value to this limit before sending it to the device.

This limit will not affect the set point display. The System Pilot will read the set point from the device and display it as read, even if outside the high and low limits. Also, this limit will only apply if the set point units are degrees F or C.

If clamping the set point results in a value that is outside the configuration limits read from the device, the System Pilot will display an error indication (“LIMIT”) and will not write the set point to the device.

Heat Set Point High Limit: Allowable Entries -40 to 245 F
Default Value 245 F

Mode Calculation — Use this decision to enable Mode Calculation. If Mode Calculation is enabled, the System Pilot will read the configured Supply Temp Variable and Fan Status Variable and compute an operating mode for this specified device while it is displaying the Remote Attach Default Screen.

Mode Calculation: Allowable Entries Enable / Disable
 Default Value Disable

Supply Temp Variable — Use this decision to specify the name of the supply air temperature variable to be used in the computation of the operating mode for this specified device. This variable will be read from the device once per minute.

Supply Temp Variable: Allowable Entries Up to 8 characters - upper case letters, numbers, -, or _
 Default Value SAT

Fan Status Variable — Use this decision to specify the name of the fan status variable to be used in the computation of the operating mode for this specified device. This variable will be read from the device once per minute.

Fan Status Variable: Allowable Entries Up to 8 characters - upper case letters, numbers, -, or _
 Default Value SFS

System Pilot Configuration (PILOTCON) Table — The System Pilot Configuration Table is shown in Table 7. An explanation of each configuration decision follows.

COMMUNICATION MODE — Use this decision to indicate whether the System Pilot is on the Carrier communicating network bus or on a local bus wired to a VVT® zone controller's COMM2 port.

If Communication Mode is Local, then the System Pilot can only attach to itself or to the VVT zone controller on the same local bus. If Communication Mode is Carrier communicating network (CCN), then the System Pilot can attach to itself or to any other Carrier network device on the network.

Communication Mode: Allowable Entries Local / CCN
 Default Value Local

BACKLIGHT ALWAYS ON — Use this decision to specify whether the backlight should remain on or turn off during inactive periods. If this decision is set to No, then the backlight will be turned off if no buttons are pressed for 30 seconds.

Backlight Always On: Allowable Entries No / Yes
 Default Value No

DISPLAY UNITS — Use this decision to specify whether numeric data values in standard table screens will be displayed in metric or US units. The default value is US and values read from the attached device will be in US units. If this decision is set to metric, the System Pilot will convert the displayed values to Metric.

Display Units: Allowable Entries US/Metric
 Default Value US

ENGLISH LANGUAGE — Use this decision to specify whether the screens will be displayed in English or another language. The default is Yes and the display will be in English. If another language package has been installed, set the decision to No and the screens will be displayed in the other language.

English Language: Allowable Entries Yes/No
 Default Value Yes

SPT SENSOR TRIM — Use this decision to trim the System Pilot's space temperature sensor if it needs calibration. For example, if the temperature displayed is two degrees above the value measured with calibrated test equipment, input a value of -2.0.

SPT Sensor Trim: Allowable Entries -9.9 to 9.9 delta F
 Default Value 0.0 delta F

SHOW NAME ON DEFAULT — Use this decision to specify whether to display the 8-character controller name on the top line of the default screen.

NOTE: If the System Pilot is on a Zone Controller's local bus, and if the zone controller's address has not been set, the System Pilot will show the Controller ID screen as the default screen. The 8-character controller name will not be displayed on the top line of this screen.

Show Name on Default: Allowable Entries No / Yes
 Default Value No

DEFAULT DEVICE (Carrier Network Mode) — The default device is the device to which the System Pilot will attach when it is powered up. It is also the device to which the System Pilot will attach if no user input is received for an hour.

If the System Pilot is on a local bus, the VVT® zone controller will automatically be the default device. If the System Pilot is on the Carrier communicating network, the user may specify the default device's Bus Number and Element Number.

→Table 7 — System Pilot Configuration (PILOTCON)

DESCRIPTION	DISPLAY	POINT	RANGE	DEFAULT
Communication Mode	Local/CCN	COMMODE	0-1	Local
Backlight Always On	No/Yes	LIGHTON	0-1	No
Display Units	US/Metric	DSPUNITS	0-1	US
English Language	No/Yes	ENGLISH	0-1	Yes
SPT Sensor Trim	xx.x ΔF	SPT_TRIM	-9.9-9.9	0.0
Show Name on Default	No/Yes	SHOWNAME	0-1	No
Default Dev: CCN Mode				
Bus Number	xxx	DEFBUSNO	0-239	0
Element Number	xxx	DEFELENO	0-239	0
Write SPT to Default	No/Yes	DEFWRITE	0-1	Yes
Zone Setpoint Limits				
Cool Setpt Low Limit	xx.x dF	C_LO_LIM	50-99	68
Cool Setpt Hi Limit	xx.x dF	C_HI_LIM	50-99	78
Heat Setpt Low Limit	xx.x dF	H_LO_LIM	50-99	65
Heat Setpt Hi Limit	xx.x dF	H_HI_LIM	50-99	75
Security Level	x	SECURITY	1-4	1
1=Full Access				
2=Setpoints, Occ, Hol				
3=Setpoints				
4=Read Only				

Default Device Bus Number — Use this decision to specify the bus number of the System Pilot's default device, if the System Pilot is on the Carrier communicating network.

Default Device
Bus Number: Allowable Entries 0 to 239
Default Value 0

Default Device Element Number — Use this decision to specify the element number of the System Pilot's default device, if the System Pilot is on the Carrier communicating network.

NOTE: If Element Number is 0, the System Pilot is on the Carrier network bus, and Remote Attach is Enabled, then the remote device will be the default device. Otherwise, the System Pilot will be the default device.

Default Device
Element Number: Allowable Entries 0 to 239
Default Value 0

WRITE SPT TO DEFAULT — Use this decision to enable or disable the System Pilot's space temperature update function. If this decision is set to Yes, the System Pilot will send its space temperature to the default device once per minute or whenever the value of the space temperature changes by 0.3° F. The System Pilot will perform this function regardless of the device to which the System Pilot is attached.

If Write SPT to Default is Yes and the user disables the feature (sets it to No) or changes the default device, the System Pilot will auto the SPT variable in the default device, allowing it to return to its own value.

When the Communication Mode decision is changed from CCN to LOCAL or when the VVT zone controller's controller address is set in the Controller ID screen, the System Pilot will set Write SPT to Default to Yes.

If Write SPT to Default is Yes and the space temperature sensor in the System Pilot fails, the System Pilot will auto the space temperature variable in the default device and issue an alarm message. The System Pilot will issue a return to normal and resume writing SPT to the default device when the sensor returns to normal.

Write SPT
To Default: Allowable Entries No / Yes
Default Value Yes

ZONE SET POINT LIMITS

Cool Setpt Low Limit — Use this decision to specify the lowest value that can be sent to the cool set point in an attached Zone Controller. If the value being sent is below this limit, the System Pilot will clamp the value to this limit before sending it.

This limit will not affect the set point display. The System Pilot will read the set point from the Zone Controller and display it as read, even if outside the high and low limits.

If clamping the set point results in a value that is outside the configuration limits read from the Zone Controller, the System Pilot will display an error indication ("LIMIT") and will not write the set point to the Zone Controller.

Cool Setpt
Low Limit: Allowable Entries 50 to 99 F
Default Value 68 F

Cool Setpt Hi Limit — Use this decision to specify the highest value that can be sent to the cool set point in an attached Zone Controller. If the value being sent is above this limit, the System Pilot will clamp the value to this limit before sending it.

This limit will not affect the set point display. The System Pilot will read the set point from the Zone Controller and display it as read, even if outside the high and low limits.

If clamping the set point results in a value that is outside the configuration limits read from the Zone Controller, the System Pilot will display an error indication ("LIMIT") and will not write the set point to the Zone Controller.

Cool Setpt
Hi Limit: Allowable Entries 50 to 99 F
Default Value 78 F

Heat Setpt Low Limit — Use this decision to specify the lowest value that can be sent to the set point in an attached Zone Controller. If the value being sent is below this limit, the System Pilot will clamp the value to this limit before sending it.

This limit will not affect the set point display. The System Pilot will read the set point from the Zone Controller and display it as read, even if outside the high and low limits.

If clamping the set point results in a value that is outside the configuration limits read from the Zone Controller, the System Pilot will display an error indication ("LIMIT") and will not write the set point to the Zone Controller.

Heat Setpt
Low Limit: Allowable Entries 50 to 99 F
Default Value 65 F

Heat Setpt Hi Limit — Use this decision to specify the highest value that can be sent to the heat set point in an attached Zone Controller. If the value being sent is above this limit, the System Pilot will clamp the value to this limit before sending it.

This limit will not affect the set point display. The System Pilot will read the set point from the Zone Controller and display it as read, even if outside the high and low limits.

If clamping the set point results in a value that is outside the configuration limits read from the Zone Controller, the System Pilot will display an error indication ("LIMIT") and will not write the set point to the Zone Controller.

Heat Setpt
Hi Limit: Allowable Entries 50 to 99 F
Default Value 75 F

→ SECURITY LEVEL — Use this decision to specify user access level. The levels are defined in Table 8. This decision can be set to level 1, 2, 3, or 4.

- 1 = Full Access
- 2 = Setpnts, Occ, Hol
- 3 = Setpoints
- 4 = Read Only

NOTE: When the user exits from this table, the System Pilot will display the Program screen for the new security level.

Security Level: Allowable Entries 1 to 4
Default Value 1

→Table 8 — Security Level Access

TYPE OF ACCESS	LEVEL 1	LEVEL 2	LEVEL 3	LEVEL 4
From default screen:				
Change set points, if applicable	Yes	Yes	Yes	No
Initiate timed override, if applicable	Yes	Yes	Yes	No
Show alternate display (3V™ controller only)	Yes	Yes	Yes	Yes
Request bus scan (3V linkage coordinator only)	Yes	Yes	Yes	Yes
From program screen:				
Attach to/ Detach from device	Yes	Yes	Yes	Yes
Edit attach list	Yes	No	No	No
Clear single line in attach list	Yes	No	No	No
Clear entire attach list	Yes	No	No	No
Read Controller ID information	Yes	Yes	Yes	Yes
Write Controller ID information	Yes	No	No	No
Controller time and date	Yes	No	No	No
Occupancy schedules	Yes	Yes	No	No
Holiday tables	Yes	Yes	No	No
Remote attach configuration table (System Pilot only)	Yes	No	No	No
Other configuration tables	Yes	No	No	No
Setpoint tables	Yes	Yes	Yes	No
Service configuration tables	Yes	No	No	No
Maintenance tables (including force/auto)	Yes	No	No	No
Status display tables (including force/auto)	Yes	No	No	No
Menu navigation	Yes	No	No	No
Alarm history display	Yes	Yes	Yes	Yes

MAINTENANCE TABLE

System Pilot Maintenance Table (PILOT-MNT) — The System Pilot Maintenance Table is shown in Table 9. The maintenance values displayed in this table are read-only values or points that can be written to (forced). Points that are forceable will be indicated.

SYSTEM PILOT STATUS SPACE TEMPERATURE — This point displays the space temperature from a thermistor located in the System Pilot.

Space Temperature: Valid Display –40.0 to 245.0 F
 Forcible? Yes

SYSTEM PILOT STATUS OUTSIDE AIR TEMPERATURE — This point displays the outside air temperature.

Outside Air Temperature: Valid Display –40.0 to 245.0 F
 Forcible? Yes

COMMUNICATION MODE — This point displays whether the System Pilot is on the Carrier communicating network bus or on a local bus wired to a VVT® zone controller’s COMM2 port.

If Communication Mode is Local, then the System Pilot is attached to itself or to the VVT zone controller on the same local bus. If Communication Mode is set to CCN, then the System Pilot is attached to itself or to another Carrier communicating device on the network.

Communication Mode: Valid Display Local / CCN
 Forcible? No

ALARMS IN ALARM HISTORY — This point displays the number of alarms currently stored in the alarm history table.

Alarms in Alarm History: Valid Display 0 to 5
 Forcible? No

CLEAR ALARM HISTORY — Forcing this decision to Yes clears all alarms in the Alarm History Table and sets this decision set back to No.

Clear Alarm History: Valid Display No / Yes
 Forcible? Yes

REMOTE ATTACH BUS NUMBER — This point displays the bus number of the Remote Device that is configured in the Remote Attach Configuration Table. The remote device can be on any Carrier network bus.

Remote Attach Bus Number: Allowable Entries 0 to 239
 Forcible? No

REMOTE ATTACH ELEMENT NUMBER — This point displays the element number of the Remote Device that is configured in the Remote Attach Configuration Table.

Remote Attach Element Number: Valid Display 0 to 239
 Forcible? No

→ **REMOTE ATTACH STATUS** — This point displays the status of the Remote Attach function. This status will be updated every 15 seconds.

- Disabled = Remote Attach Enable is Disabled
- Enabled = Remote Attach Enable is Enabled

Remote Attach Status: Valid Display Disabled, Enabled
 Forcible? No

ATTACHED DEVICE BUS NUMBER — This point displays the bus number of the attached device.

Attached Device Bus Number: Valid Display 0 to 239
 Forcible? No

ATTACHED DEVICE ELEMENT NUMBER — This point displays the element number of the attached device.

Attached Device
 Element Number: Valid Display 0 to 239
 Forcible? No

ATTACHED DEVICE NAME — This point displays the name of the attached device.

Attached
 Device Name: Valid Display Up to 8 characters - upper case letters, numbers, -, or _
 Forcible? No

→Table 9 — System Pilot Maintenance (PILOTMNT)

DESCRIPTION	DISPLAY	POINT	RANGE	DEFAULT
System Pilot Status				
Space Temperature	xxx.x °F	SPT	-40-245	-40
Outside Air Temp	xxx.x °F	OAT	-40-245	-40
Communication Mode	Local/CCN	COMMODE		Local
Alarms in Alarm History	x	NUM_ALARM		0
Clear Alarm History	No/Yes	CLR_ALARM	Yes/No	No
Remote Attach				
Bus Number	xxx	RABUSNO		0
Element Number	xxx	RAELENO		0
Status	XXXXXXXX	RASTATUS		Disabled
Attached Device				
Bus Number	xxx	ATBUSNO		(See Note 1)
Element Number	xxx	ATELENO		(See Note 1)
Device Name	XXXXXXXX	ATDEVNAM		SYSPILOT

NOTES:

1. Defaults are the System Pilot element number and bus number.
2. Remote Attach Status text: "Disabled" or "Enabled."

Manufacturer reserves the right to discontinue, or change at any time, specifications or designs without notice and without incurring obligations.