



Carrier VFD Quick Reference

Instruction Manual D2-3466-2



Carrier

A United Technologies Company

Rockwell
Automation

The information in this manual is subject to change without notice.

Throughout this manual, the following notes are used to alert you to safety considerations:



ATTENTION: Identifies information about practices or circumstances that can lead to personal injury or death, property damage, or economic loss.

Important: Identifies information that is critical for successful application and understanding of the product.

The thick black bar shown on the outside margin of this page will be used throughout this instruction manual to signify new or revised text or figures.



ATTENTION: Only qualified electrical personnel familiar with the construction and operation of this equipment and the hazards involved should install, adjust, operate, or service this equipment. Read and understand this manual and other applicable manuals in their entirety before proceeding. Failure to observe this precaution could result in severe bodily injury or loss of life.

ATTENTION: DC bus capacitors retain hazardous voltages after input power has been disconnected. After disconnecting input power, wait five (5) minutes for the DC bus capacitors to discharge and then check the voltage with a voltmeter to ensure the DC bus capacitors are discharged before touching any internal components. Failure to observe this precaution could result in severe bodily injury or loss of life.

ATTENTION: The drive can operate at and maintain zero speed. The user is responsible for assuring safe conditions for operating personnel by providing suitable guards, audible or visual alarms, or other devices to indicate that the drive is operating or may operate at or near zero speed. Failure to observe this precaution could result in severe bodily injury or loss of life.

ATTENTION: Do not install modification kits with power applied to the drive. Disconnect and lock out incoming power before attempting such installation or removal. Failure to observe this precaution could result in severe bodily injury or loss of life.

ATTENTION: The user must provide an external, hardwired emergency stop circuit outside of the drive circuitry. This circuit must disable the system in case of improper operation. Uncontrolled machine operation may result if this procedure is not followed. Failure to observe this precaution could result in bodily injury.

ATTENTION: The user is responsible for conforming with all applicable local, national, and international codes. Failure to observe this precaution could result in damage to, or destruction of, the equipment.



ATTENTION: When the level-sense start feature is enabled (P.054 = ON), the user must ensure that automatic start up of the driven equipment will not cause injury to operating personnel or damage to the driven equipment. In addition, the user is responsible for providing suitable audible or visual alarms or other devices to indicate that this function is enabled and the drive may start at any moment. Refer to the LiquiFlo Software Start-Up and Reference manual (D2-3410) for additional information. Failure to observe this precaution could result in severe bodily injury or loss of life.

ATTENTION: When P.055 is set to ON, the STOP/RESET key is functional only from the selected control source. As a safety precaution, Reliance recommends that an emergency stop input be located near the equipment. As a further safety precaution, the user should post a warning on the drive to alert personnel that the STOP/RESET key is not functional. Failure to observe this precaution could result in severe bodily injury or loss of life.

ATTENTION: Unused wires in conduit must be grounded at both ends to avoid a possible shock hazard caused by induced voltages. Also, if a drive sharing a conduit is being serviced or installed, all drives using this conduit should be disabled to eliminate the possible shock hazard from cross-coupled motor leads. Failure to observe these precautions could result in bodily injury.

ATTENTION: The drive contains printed circuit boards that are static-sensitive. Anyone who touches the drive components should wear an anti-static wrist band. Erratic machine operation and damage to, or destruction of, equipment can result if this procedure is not followed. Failure to observe this precaution can result in bodily injury.

ATTENTION: If a maintained start contact is used when the control source = rE, switching from local to remote from the terminal strip will cause power to be applied to the motor if the remote start contact is closed. Stay clear of rotating machinery in this case. Failure to observe this precaution could result in bodily injury.

ATTENTION: The drive is not equipped with a coast-stop pushbutton. You must install a hardwired operator-accessible pushbutton that provides a positive interrupt and shuts down the drive. See the LiquiFlo AC Power Modules Hardware Reference, Installation, and Troubleshooting manual (D2-3411) for wiring information. Failure to observe this precaution could result in bodily injury.

ATTENTION: The user is responsible for ensuring that driven machinery, all drive-train mechanisms, and application material are capable of safe operation at the maximum operating speed of the drive. In V/Hz regulation, overfrequency protection in the drive is provided by means of H.022. Failure to observe this precaution could result in bodily injury.

ATTENTION: The setting of parameters H.001 (Motor Nameplate Base Frequency), and P.004 (Maximum Speed) determines the motor maximum speed. These parameters must be set by a qualified person who understands the significance of setting them accurately. Failure to observe this precaution could result in bodily injury.

ATTENTION: When switching from auto to manual, or manual to auto, the drive will ramp to the reference level provided by the new source at the rate specified in P.001 (Accel Time 1), P.002 (Decel Time 1), P.017 (Accel Time 2), or P.018 (Decel Time 2). Be aware that an abrupt speed change may occur depending upon the new reference level and the rate specified in these parameters. Failure to observe this precaution could result in bodily injury.

ATTENTION: It is the user's responsibility to determine how to distribute the passwords. Reliance Electric is not responsible for unauthorized access violations within the user's organization. Failure to observe this precaution could result in bodily injury.

ATTENTION: Do not alter the setting of any jumper not described in LiquiFlo Hardware Reference manual (D2-3411). Failure to observe this precaution could result in damage to, or destruction of, the equipment.

ATTENTION: For single-motor applications with no external thermal overload relay, P.040 (Motor Overload Enable) should always be set to ON. Failure to observe this precaution could result in damage to, or destruction of, the equipment.



ATTENTION: Use of power correction capacitors on the output of the drive can result in erratic operation of the motor, nuisance tripping, and/or permanent damage to the drive. Remove power correction capacitors before proceeding. Failure to observe this precaution could result in damage to, or destruction of, the equipment.

ATTENTION: Most codes require that upstream branch circuit protection be provided to protect input power wiring. Install the fuses recommended in table 3.7 of the LiquiFlo Hardware Reference manual (D2-3411). Do not exceed the fuse ratings. Failure to observe this precaution could result in damage to, or destruction of, the equipment.

ATTENTION: Do not route signal and control wiring with power wiring in the same conduit. This can cause interference with drive operation. Failure to observe this precaution could result in damage to, or destruction of, the equipment.

ATTENTION: Distribution system short circuit capacity shall not exceed the rating of the drive. Failure to observe this precaution could result in damage to, or destruction of, the equipment.

ATTENTION: H.002 (Motor Nameplate Amps) must not exceed the rated amps found on the motor nameplate. Overcurrent or excess heating of the motor could result if this is not done. Failure to observe this precaution could result in damage to, or destruction of, the equipment.

The following ATTENTION statements do not apply to the default Carrier VFD configuration. However, they do apply to the Reliance LiquiFlo AC Power Module.

ATTENTION: As a safety precaution, Reliance Electric recommends that you provide an audible or visual alarm to indicate that the level sense start feature is enabled and the motor can start when power is applied to the drive. You should also post warnings on the motor, the drive, and any other applicable equipment to alert personnel that the application uses an automatic start-up feature. Failure to observe this precaution could result in severe bodily injury or loss of life.

ATTENTION: Be aware of the following before enabling the level sense start function (P.054):

- Setting P.054 to ON immediately applies output power to the motor when all start conditions are met.
- If the drive is running from the terminal strip, both the start and stop inputs are closed. If P.054 = ON and a fault occurs, the drive coasts to rest and generates a fault. In this case, resetting and clearing the fault immediately restarts the drive without any change to the start or stop input states
- If P.026 (Function Loss Response) = 1, the control source is the terminal strip (start and stop inputs are closed), and P.054 = ON, the drive coasts to rest if the function loss input is opened and does not generate a fault. In this case, closing the function loss input immediately starts the drive without any change to the start or stop input.

When this function is enabled, the user must ensure that automatic start up of the driven equipment will not cause injury to operating personnel or damage to the driven equipment. In addition, the user is responsible for providing suitable audible or visual alarms or other devices to indicate that this function is enabled and the drive may start at any moment. Failure to observe this precaution could result in severe bodily injury or loss of life.

ATTENTION: If P.062 (Option Port: Communication Loss Response) = 2 and P.054 (Level Sense Start Enable) = ON and network communication is lost while the drive is running, the terminal strip stop input will function as a STOP/RUN input. If the terminal strip stop input is opened, the drive will stop. If the terminal strip stop input is closed, the drive will re-start. Failure to observe this precaution could result in severe bodily injury or loss of life.

ATTENTION: When starting with search enabled (H.016 is set to any value but OFF), there will be a several second delay, and the motor may drift in the forward and reverse direction, before the motor begins operating in the desired direction even if reverse has been disabled in P.027. Stay clear of rotating machinery. Failure to observe this precaution could result in bodily injury.



ATTENTION: When connected to a non-regenerative common DC bus, regeneration may cause a rise in DC bus voltage. Be aware that other drives on the bus may experience an unexpected speed increase due to the high bus voltage. Failure to observe this precaution may result in bodily injury.

ATTENTION: The motor shaft can rotate in either direction by up to one (1) revolution, providing minimum torque immediately after the identification procedure (initiated in H.020) has been started. Stay clear of rotating machinery. Failure to observe this precaution could result in bodily injury.

ATTENTION: In V/Hz regulation, if P.000 (Control Source) is set to OP (Option Port), and P.062 is set to 1 (Hold Last Reference), and the drive loses communication with the network, the drive will maintain the last frequency command sent to it. Ensure that driven machinery, all drive-train mechanisms, and application material are capable of safe operation at the maximum operating speed of the drive. Failure to observe this precaution could result in bodily injury.

ATTENTION: Carrier Frequency (P.047) and Current Limit (P.005) must be set correctly before activating the identification procedure (H.020) to avoid motor overloading and/or overheating. Failure to observe this precaution could result in damage to, or destruction of, the equipment.

ATTENTION: The motor can rotate in the reverse direction during the identification procedure (H.020) even if reverse disable has been selected in P.027. Uncouple the motor from any driven machinery that could be damaged by reverse rotation. Failure to observe this precaution could result in damage to, or destruction of, the equipment.

CONTENTS

Chapter 1

Using This Manual

- 1.1 Required Publications..... 1-1
- 1.2 Getting Assistance from Reliance Electric..... 1-1

Chapter 2

Identifying Drive Components Using Reference Drawings and Parts Lists

- 2.1 VFD Chiller Installation Drawing (500A and 643A VFD) 2-1
- 2.2 Front View of 500 and 643 Amp VFD with Parts List
(19XV04000601 rev 4.0) 2-3
- 2.3 500 Amp and 643 Amp 19XRV Drive Module Component
Locations and Parts List 2-4
- 2.4 Front View of 414 Amp VFD with Parts List (19XV04003001 rev 2.0) 2-5
- 2.5 414 Amp 19XRV Drive Module Component Locations and Parts List..... 2-6
- 2.6 414 Amp 19XRV Drive Wiring Diagrams 2-7
- 2.7 VFD System Wiring Diagram (19XV05007901 rev A) 2-9
- 2.8 500 Amp and 643 Amp 19XRV Drive Wiring Diagrams 2-14

Chapter 3

Using the Keypad/Display to Program, Monitor, and Control the Drive.....3-1

Chapter 4

Identifying Parameter Defaults For Carrier Drives.....4-1

Chapter 5

Verifying the Installation5-1

Chapter 6

Troubleshooting the Drive

- 6.1 Test Equipment Needed To Troubleshoot..... 6-1
- 6.2 Verifying That DC Bus Capacitors Are Discharged 6-1
- 6.3 Checking the Power Modules and Motor with Input Power Off 6-4
- 6.4 Troubleshooting the Drive Using Error Codes..... 6-6
 - 6.4.1 Identifying Alarm Codes and Recovering 6-7
 - 6.4.2 Identifying Fault Codes and Recovering 6-8
 - 6.4.3 Accessing, Reading, and Clearing the Faults in the Error Log..... 6-11
- 6.5 Identifying Fatal Fault Codes and Recovering..... 6-14
- 6.6 Identifying PMC Board Fault Codes and Recovering 6-15
- 6.7 Resetting a Checksum (CHS) Fault 6-15

Using This Manual

The Carrier VFD Quick Reference is intended for qualified Carrier service personnel, and is to be used during start up, operation, and maintenance of the variable speed drive.

1.1 Required Publications

The Carrier VFD Quick Reference must be used with the following manuals:

- D2-3410 LiquiFlo AC General Purpose (Volts/Hertz) and Vector Duty Drive Software Start-Up and Reference Manual
- D2-3411 LiquiFlo AC Power Modules Hardware Reference, Installation, and Troubleshooting
- D2-3341 Super Remote Meter Interface (RMI) Board for GV3000 and LiquiFlo AC Drives
- D2-3448 Control and Configuration Software
- 531-982 19XR, XRV Start-Up, Operation, and Maintenance Instructions (19XR-5SS)

1.2 Getting Assistance from Reliance Electric

If you have any questions or problems with the products described in this manual, contact your local Reliance Electric sales office. For technical assistance, call 1-864-284-5444.

Before calling, have the following information available (from the Reliance label):

- Reliance model number
- Carrier part number
- Serial number
- Carrier drawing number and revision

CHAPTER 2

Identifying Drive Components Using Reference Drawings and Parts Lists

Replace with 2.fm (11 X 17 Z-fold)

Using the Keypad/Display to Program, Monitor, and Control the Drive

If you are unfamiliar with the detailed operation of the keypad/display, refer to chapter 3 of the LiquiFlo Software Start-Up and Reference Manual (D2-3410).

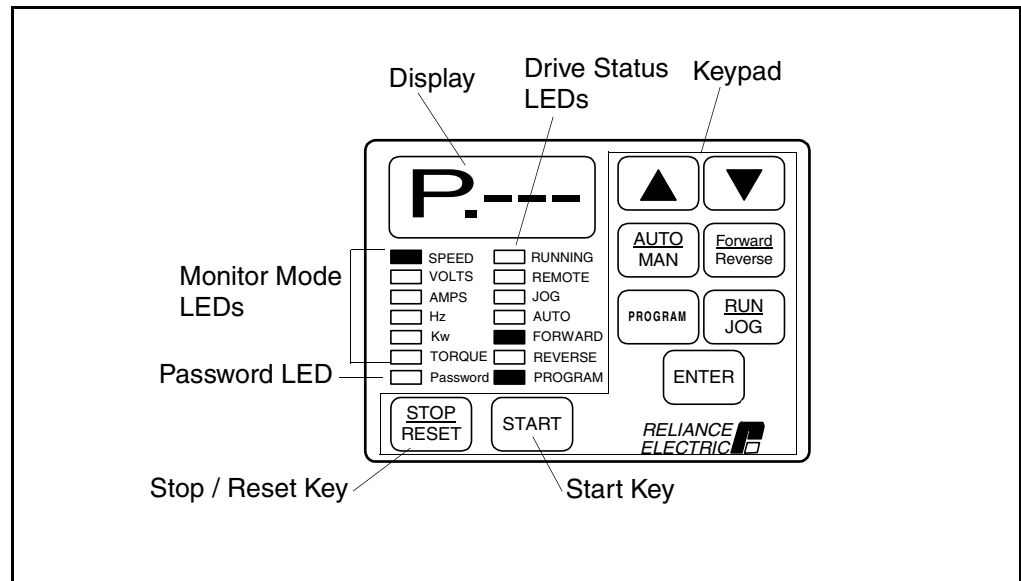

Figure 3.1 – Keypad/Display



ATTENTION: When switching from auto to manual, or manual to auto, the drive will ramp to the reference level provided by the new source at the rate specified in P.001 (Accel Time 1), P.002 (Decel Time 1), P.017 (Accel Time 2), or P.018 (Decel Time 2). Be aware that an abrupt speed change may occur depending upon the new reference level and the rate specified in these parameters. Failure to observe this precaution could result in bodily injury.

CHAPTER 4

Identifying Parameter Defaults For Carrier Drives

Use the following table to identify and set the parameter defaults for Carrier drives.

Important: Setting P.050 (Restore Defaults) to ON will restore the drive to Reliance defaults, not Carrier defaults. If this has been done, set the following parameters to restore Carrier defaults.

Parameter No.	Parameter Name	Setting
P.000	Control Source	rE
P.001	Accel Time 1	8
P.002	Decel Time 1	20
P.003	Minimum Speed	0.5
P.004	Maximum Speed	Job-specific (50 or 60)
P.005	Current Limit	110
P.009 ¹	Terminal Strip Analog Input Offset	-10
P.010 ¹	Terminal Strip Analog Input Gain	0.99 (50LR4060, 64LR4060) 1.030 (41LR4060)
P.011	Terminal Strip Analog Input Configure	4
P.013	Output Relay Configuration	2
P.027	Forward/Reverse Configuration	1
P.028	Speed Display Scaling	Job-specific
P.043	Fault Auto Reset Attempts	10
P.044	Fault Auto Reset Time	30
P.052	AUTO/MAN Key Disable	ON
H.000	Motor Nameplate Volts	Job-specific
H.001	Motor Nameplate Base Frequency	Job-specific
H.002	Motor Nameplate Amps	1.03 x Motor Nameplate Amps
H.021	AC Line Volts	Job-specific
H.022	Overfrequency Limit	Job-specific (57 or 69)
r.001	Analog Output 1 Source	4
r.002 ¹	Analog Output 1 Offset	60 (50LR4060, 64LR4060) 135 (41LR4060)
r.003 ¹	Analog Output 1 Gain	0.505 (50LR4060, 64LR4060) 0.503 (41LR4060)
r.035	Relay Output 1 (NO) Configuration	5
r.036	Relay Output 2 (NO/NC) Configuration	2
r.037	Relay Output 3 (NO/NC) Configuration	1
r.046	Relay Output 3 Delay Time	-999
r.050	Speed Detection Level 1	35

¹These parameters must be tuned or calibrated per the VFD Control Verification procedures (running and non-running) found in the Carrier 19XR/XRV Start-Up, Operation, and Maintenance Instructions on pages 59-60.

For job-specific parameters, refer to the 19XR, XRV Start-Up, Operation, and Maintenance Instructions manual (531-982) for further instructions. For descriptions of all parameters, refer to the LiquiFlo Software Start-Up and Reference manual (D2-3410).

Verifying the Installation

Record the following job information:

1. Job Name: _____
2. Job Number: _____
3. City: _____
4. State: _____
5. Zip Code: _____

Record the following nameplate information:

1. Chiller Serial Number: _____
2. VFD Part Number: _____
3. VFD Serial Number: _____
4. Motor Rated Load Amps: _____
5. Incoming Voltage: _____
6. Incoming Frequency: _____
7. Carrier Part Number
and Revision: _____
8. ICVC Software Number: _____

Troubleshooting the Drive

This chapter describes how to troubleshoot the drive and the equipment that is needed to do so.

6.1 Test Equipment Needed To Troubleshoot

An isolated multimeter will be needed to measure DC bus voltage and to make resistance checks. Note that dedicated troubleshooting test points are not provided.

6.2 Verifying That DC Bus Capacitors Are Discharged



ATTENTION: DC bus capacitors retain hazardous voltages after input power has been disconnected. After disconnecting input power, wait five (5) minutes for the DC bus capacitors to discharge and then check the voltage with a voltmeter to ensure the DC bus capacitors are discharged before touching any internal components. Failure to observe this precaution could result in severe bodily injury or loss of life.

The drive's DC bus capacitors retain hazardous voltages after input power has been disconnected. Perform the following steps before touching any internal components:

- Step 1. Turn off and lock out input power. Wait five minutes.
- Step 2. Verify that there is no voltage at the drive's input power terminals.
- Step 3. Measure the DC bus potential with a voltmeter while standing on a non-conductive surface and wearing insulated gloves (1000 V).

Measure the DC bus potential at the test points on the Power Module Interface board. See figure 6.1 for 414 amp drives; see figure 6.2 for 500 amp and 643 amp drives.

- Step 4. Once the drive has been serviced, reapply input power.

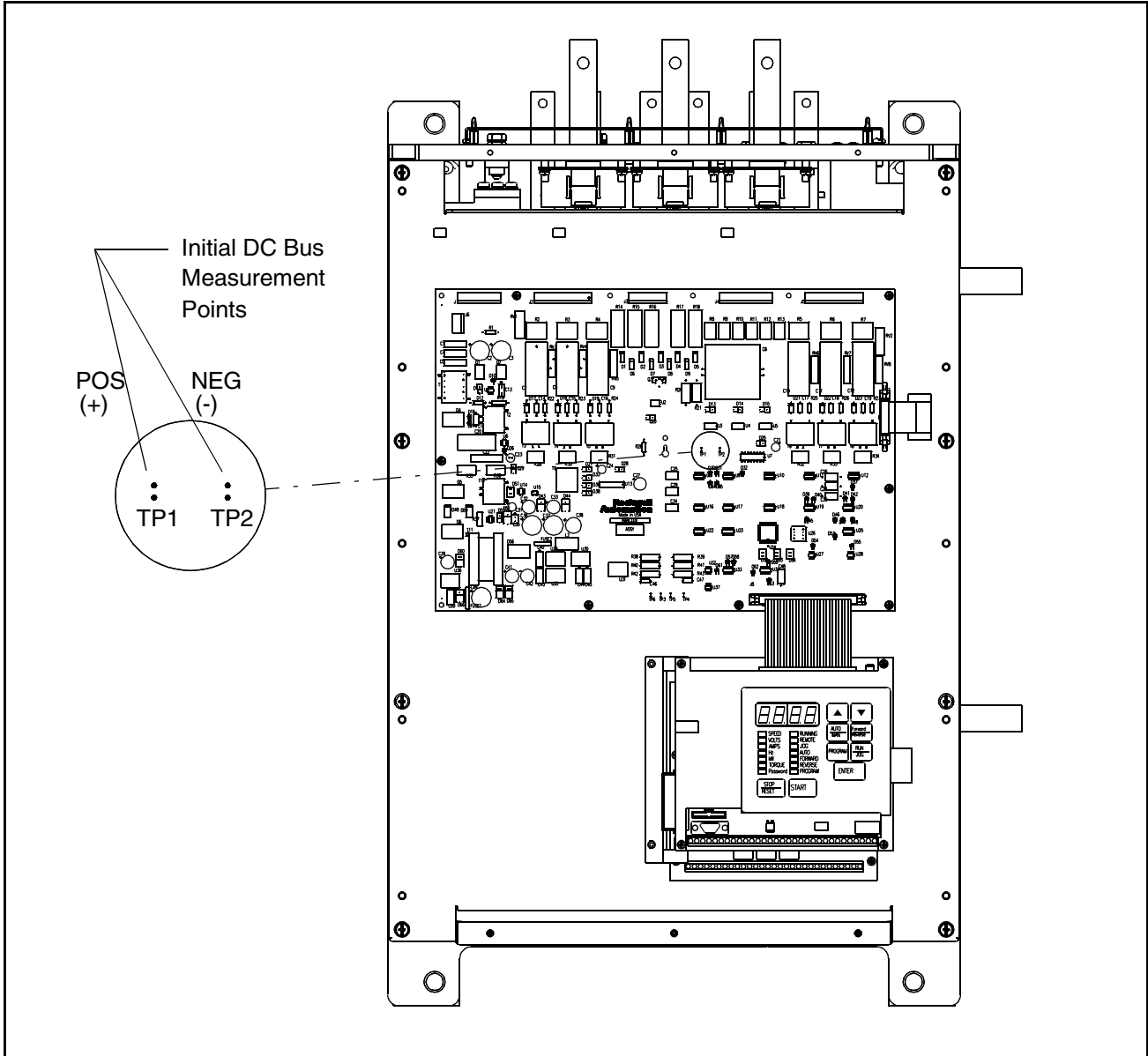

Figure 6.1 – DC Bus Voltage Terminals (414 Amp Drives)

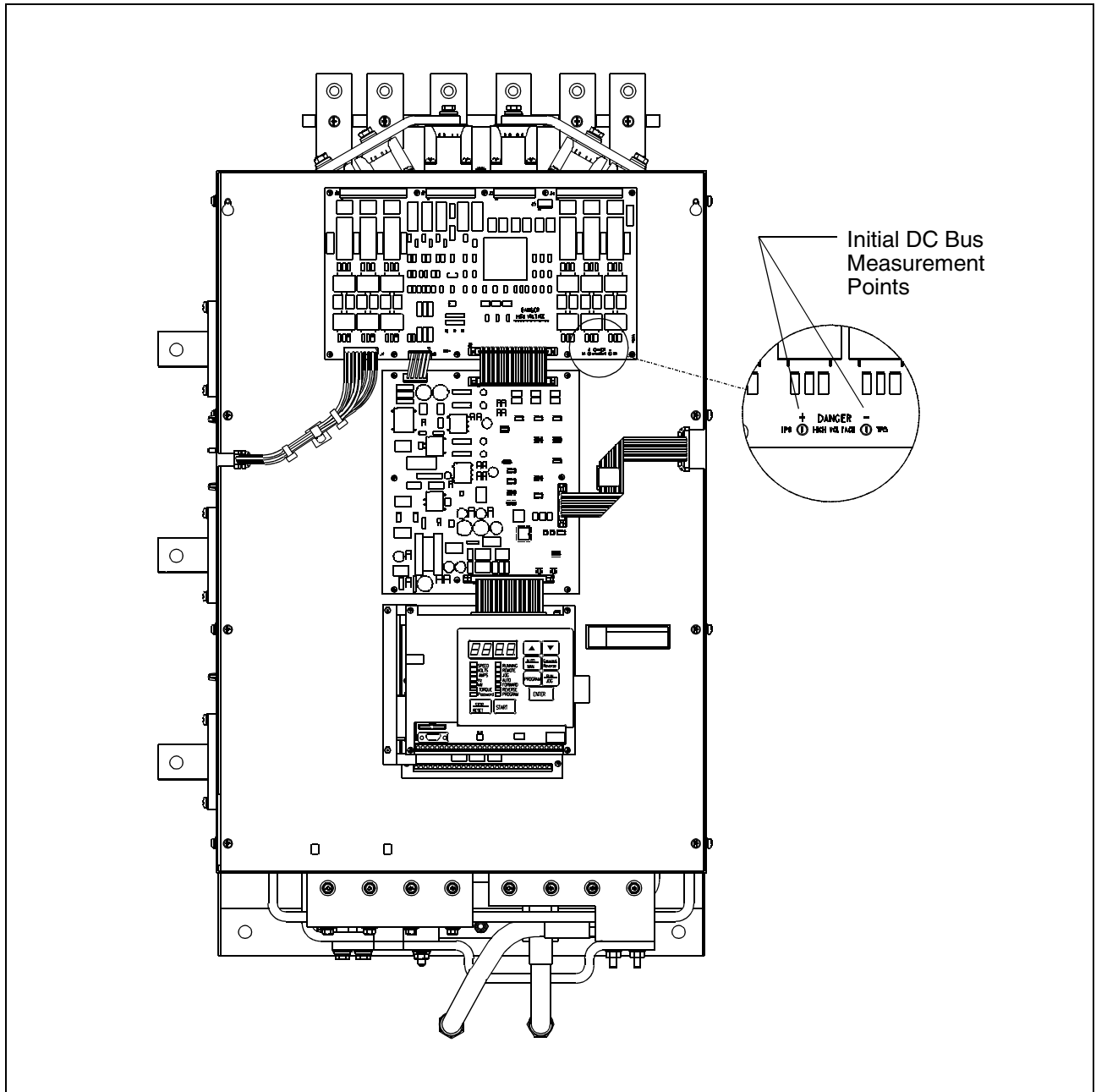

Figure 6.2 – DC Bus Voltage Terminals (500 Amp and 643 Amp Drives)

6.3 Checking the Power Modules and Motor with Input Power Off

Use the following procedure to check the drive's Power Module circuitry with power off:



ATTENTION: DC bus capacitors retain hazardous voltages after input power has been disconnected. After disconnecting input power, wait five (5) minutes for the DC bus capacitors to discharge and then check the voltage with a voltmeter to ensure the DC bus capacitors are discharged before touching any internal components. Failure to observe this precaution could result in severe bodily injury or loss of life.

- Step 1. Turn off and lock out input power. Wait five minutes.
- Step 2. Verify that there is no voltage at the drive's input power terminals.
- Step 3. Check the DC bus potential with a voltmeter as described in section 6.2 to ensure that the DC bus capacitors are discharged.
- Step 4. Disconnect the motor from the drive.
- Step 5. Check all AC line and DC bus fuses.
- Step 6. If a fuse is open, use a multimeter to check the input diodes and output IGBTs. See table 6.1.
- Step 7. Check motor impedance.
- Step 8. Reconnect the motor to the drive.
- Step 9. Reapply input power.

Table 6.1 – Resistance Checks

Input Diode No.	Meter Connection		Component is OK if resistance (R) is:	Component is defective if:
	(+)	(-)		
1	*	SCR1	10 < R < 1 megohm	Continuity (short circuit) or open when the meter is connected with reversed polarity.
2	*	SCR2		
3	*	SCR3		
4	*	SCR4		
5	*	SCR5		
6	*	SCR6		
7		SCR1 **		
8		SCR2 **		
9		SCR3 **		
10		SCR4 **		
11		SCR5 **		
12		SCR6 **		
* (+) DC Bus Volts power terminal ** (-) DC Bus Volts power terminal				

Table 6.1 - Resistance Checks (Continued)

IGBT No.	Meter Connection		Component is OK if resistance (R) is:	Component is defective if:
	(+)	(-)		
1	*	W/T3	10 < R < 1 megohm	Continuity (short circuit) or open when the meter is connected with reversed polarity.
2	*	V/T2		
3	*	U/T1		
4		W/T3 **		
5		V/T2 **		
6		U/T1 **		
* (+) DC Bus Volts power terminal ** (-) DC Bus Volts power terminal				

6.4 Troubleshooting the Drive Using Error Codes

The drive can display two kinds of error codes, called alarm and fault codes, to signal a problem detected during self tuning or drive operation. Fault and alarm codes are shown in tables 6.2 and 6.3. A special type of fault code, which occurs rarely, is the fatal fault code. If the code you see is not in tables 6.2 or 6.3, refer to section 6.5 .

Alarm Codes

An alarm condition is signified by a two- or three-letter code flashing on the display. The drive will continue to operate during the alarm condition. You should investigate the cause of the alarm to ensure that it does not lead to a fault condition. The alarm code remains on the display as long as the alarm condition exists. The drive automatically clears the alarm code when the condition causing it is removed.

Fault Codes

A fault condition is also signified by a two- or three-letter code flashing on the display. If a fault occurs, the drive coasts to stop and the RUNNING LED turns off. The first fault detected is maintained flashing on the display, regardless of whether other faults occur after it. The fault code remains on the display until it is cleared by the operator using the STOP/RESET key or using the fault reset input from the selected control source (P.000).

Error Log

The drive automatically stores all fault codes for faults that have occurred in the system error log. The error log is accessible through the keypad, the optional OIM, or the optional CS3000 software. There is no visual indication that there are faults in the log. You must access the error log to view the faults.

The error log holds the 10 most recent faults that have occurred. The last fault to occur is the first one to appear on the display when you access the error log. The faults in the log are numbered sequentially. The most recent fault is identified with the highest number (up to 9). Once the log is full, older faults are discarded from the log as new faults occur.

For each entry in the error log, the system also displays the day and time that the fault occurred. The day data is based on a relative 247-day counter (rolls over after 247.55). The time is based on a 24-hour clock. The first digits of the clock data represent hours. The last two digits represent minutes. The clock can be reset using P.030 (Elapsed Time Meter Reset).

All entries in the error log and the day and time data are retained if power is lost. Refer to section 6.4.3 for the procedure for accessing and clearing the error log using the keypad.

6.4.1 Identifying Alarm Codes and Recovering

Drive alarm codes are shown in table 6.2. Note that the alarm code will only be displayed for as long as the problem exists. Once the problem has been corrected, the alarm code will disappear from the display.

Table 6.2 – List of Alarm Codes

Code	Alarm Description	Alarm Cause	Corrective Action
HIdc	High DC bus voltage	The DC bus is charged above the trip threshold. (If U.018 > 415, DC bus is above 741 VDC. If U.018 ≤ 415, DC bus is above 669 VDC.)	<p>Increase the deceleration time in P.002, P.018.</p> <p>Install optional snubber resistor braking kit.</p> <p>Verify that the AC input is within specification. Install an isolation transformer if required.</p> <p>Check the actual line voltage against U.018.</p>
I-Ac	V/Hz identification procedure active	V/Hz identification procedure is enabled and in progress.	<p>Allow identification procedure to finish.</p> <p>Press keypad STOP/RESET to cancel identification procedure if desired.</p>
I-En	V/Hz identification procedure enabled	H.020 = On; V/Hz identification procedure has been enabled but not started.	<p>Proceed with V/Hz identification procedure, start drive and allow procedure to begin. Display will change to I-Ac when drive is started.</p> <p>Change H.020 to OFF to cancel identification and clear I-En if desired.</p>
LIL	Low AC input line	AC input line is low. For SVC, indicates DC bus is being regulated. No corrective action is required.	Adjust line voltage parameter (H.021 or U.018) to match actual AC line voltage.
S-Ac	Vector self-tuning active	Vector self-tuning is enabled and in progress.	<p>Allow vector self-tuning procedure to finish.</p> <p>Press keypad STOP/RESET to cancel vector self-tuning procedure if desired.</p>
S-En	Vector self-tuning enabled	U.008 = On; vector self-tuning has been enabled but not started.	<p>Proceed with vector self-tuning, start drive and allow self-tuning procedure to begin. Display will change to S-Ac when drive is started.</p> <p>Change U.008 to OFF to cancel self-tuning and clear S-En if desired.</p>

6.4.2 Identifying Fault Codes and Recovering



ATTENTION: DC bus capacitors retain hazardous voltages after input power has been disconnected. After disconnecting input power, wait five minutes for the DC bus capacitors to discharge and then check the voltage with a voltmeter to ensure the DC bus capacitors are discharged before touching any internal components. Failure to observe this precaution could result in severe bodily injury or loss of life.

Drive fault codes are shown in table 6.3. To clear a single fault that has occurred so that the drive can be started again, correct any problems indicated by the fault code and press the STOP/RESET key on the keypad, or assert the fault reset from the selected control source (P.000). Because multiple faults can occur and only the first will be displayed, you must access the error log in order to view all of the faults that have occurred. See section 6.4.3 for instructions on how to view the error log.

Table 6.3 – List of Fault Codes

Code	Fault Description	Fault Cause	Corrective Action
AIn	Analog input signal loss	P.011 = 4 or 5 and 4 to 20 mA analog input is below 1 mA.	Verify that P.011 is set correctly. Check that the analog input source supply ≥ 1 mA.
bYC	Incorrect precharge status	Precharge initiated and incorrect precharge status is returned.	Check operation of the precharge.
CHS	Default parameter restore (checksum error)	During drive operation: Regulator board failure. After Regulator board replacement:	Contact Reliance or replace Regulator board. Contact Reliance.
EC	Earth current failure (ground fault)	Unintentional grounding of the input.	Check isolation between ground and output terminals. Possible leakage, current sensor defects; replace sensor.
EEr	Non-volatile memory write failure	Failure on write to non-volatile memory.	Connect CS3000 software to upload parameters or record by hand. Then replace Regulator board. Parameter values will be lost when power is cycled.
EL	Encoder loss	Drive is not detecting feedback from the encoder. For SVC operation, conditions exist for more than 5 seconds that may result in an inability to complete a ramp-to-rest stop.	Check the connection between the encoder and the drive. Check the encoder/motor coupling. For SVC operation, check motor data parameters. Check U.006. Incorrect magnetizing current may be generated by performing self-tuning with a load connected to the motor.
FL	Function loss	Function loss input on control terminal is opened.	Check external interlocks at terminals 16, 20.
HId	High time identification aborted	Identification process for V/Hz has been aborted.	See H.019 for identification result.
HIL	High line voltage	Input voltage more than 15% above nominal.	Check actual line voltage against U.018 or H.021.

Table 6.3 – List of Fault Codes (Continued)

Code	Fault Description	Fault Cause	Corrective Action
HU	High DC bus voltage	DC bus voltage too high (capacitor protection).	Check input line voltage; if necessary, add transformer.
		Deceleration time too short.	Increase deceleration time P.002/P.018/P.023 versus Maximum Speed/Hz (P.004). Install DB option with resistors.
IPL	Input phase loss	Voltage ripple on DC bus due to missing input phase or an imbalance between phases.	Verify that proper voltage is being applied to the drive. Check all phases.
LU	Low DC bus voltage	DC bus voltage too low. Line dip too long (P.042).	Check input voltage, line fuses. If necessary, add transformer. Check value of Ride Through Time (P.042), Line Voltage (H.021, U.018).
		Input rectifier diodes defective.	Check DC bus voltage. If incorrect, replace diode set.
nCL	Network comm loss	Communications with the AutoMax network have been lost.	Check network cabling from network master to network option board. Check that network master is operating properly.
nId	Identification Request not yet performed (V/Hz only)	Drive started but Identification Result = Zero.	Reset fault. Perform Identification Request. Restart drive.
OC	Overcurrent (steady state). Trips between 185 to 200% load (based on inverter type current) check Power Module rating.	Output phase-to-phase short.	Check isolation between each output line.
		Bus voltage line-to-line.	Check transistor modules for correct output. If incorrect, possible board defect; replace. Possible Hall effect current sensor defective; replace.
		Ground fault.	Check isolation between ground and output terminals. Possible leakage current sensor defect; replace sensor.
		Momentary overload.	Check for motor overload; reduce load on motor.
		Bad motor.	Check motor for correct operation.
		Torque boost / V/Hz too high (V/Hz).	Check parameters H.001, H.002, and/or H.003. Enable Identification Request (H.020)
		Motor unknown to regulator (V/Hz).	Check that regulator was updated with actual motor characteristics via Identification Request (H.020).
		Parameter settings (vector).	Check Encoder PPR (U.001), Motor Poles (U.002), Base Frequency (U.003), Motor Nameplate Amps (U.004), Magnetizing Current (U.006), Speed Regulator Prop. Gain (U.012).
		Encoder wired incorrectly, wrong PPR.	Check encoder wiring. Perform vector self-tuning.
OCA	Overcurrent (at acceleration)	Overcurrent condition occurred while accelerating. Acceleration time too short.	See OC fault corrective actions. Increase acceleration time (P.001, P.017, P.021).

Table 6.3 – List of Fault Codes (Continued)

Code	Fault Description	Fault Cause	Corrective Action
OCb	Overcurrent (at DC braking)	DC voltage too high.	Check parameters H.006, H.007.
OCd	Overcurrent (at deceleration)	Overcurrent condition occurred while decelerating. Deceleration time too short.	See OC fault corrective actions. Increase deceleration time (P.002, P.018, P.022).
OF	Overfrequency	Drive has exceeded maximum allowable output frequency. Regenerating energy is too high. Stability or slip compensation circuit adds frequency reference. If H.016 ON, searching current is too high. Motor is too small.	Vector: Check parameters Encoder PPR (U.001), Motor Poles (U.002), Base Frequency (U.003). V/Hz: Check DC bus voltage; increase decelerating time. Check values Max Speed (P.004) / Overfreq. (H.022). Check slip compensation (H.004). If H.016 ON, check motor size versus Power Module size, recheck setting of P.005 (too high).
OH	Drive overtemperature	Cooling fan failure.	Check ambient temperature, cooling fan, minimum clearances around drive.
OL	Motor overload	Excess motor current. V/Hz: Torque boost too high, therm. overload level too low.	Vector: Check actual/Motor Rated Nameplate Amps (U.004) V/Hz: Check actual current/Torque Boost (H.003). Check that Power Module is sized correctly. Reduce load on motor (for example, at low frequency).
		Excess load on motor, for example, at too low speeds.	Check that Power Module is sized correctly. Reduce load on motor (e.g., at low frequency).
		Loss of phase connection.	Check output lines to the motor.
OPL	Motor output phase loss	Phase lost between drive and motor.	Check connections and cable of all 3 phases and motor windings. Replace any damaged cable.
OSP	Overspeed (Vector only)	RPM above 130% Maximum Speed (P.004), speed regulator response not optimized.	Check Encoder PPR (U.001), Motor Poles (U.002), Base Frequency (U.003), Motor Nameplate RPM Speed (U.005). Check Reg. Proportional (U.012) Integral Gain (U.013)
PUc	Missing Power Module ID connector	Bad or disconnected cable between Regulator and Power Module.	Check cables between Regulator board and Power Module.
PUn	Power Module not identified	Drive parameters have been restored to power-up defaults. Regulator has not been configured to match Power Module.	Power Module must be configured by Reliance service personnel.
PUo	Drive power electronic overload	Power Module overloaded. Too high DC Braking Current (H.007) or Torque Boost (H.003).	Check load to Power Module. Check Power Module sizing versus application. Check DC Braking Current value (H.007). Check Torque Boost (H.003).
SF	Self-tuning status (Vector only)		See parameter U.009

Table 6.3 – List of Fault Codes (Continued)

Code	Fault Description	Fault Cause	Corrective Action
SrL	Communication loss between Regulator/PC/OIM	Serial port communication cable, PC or OIM communication port setup.	Check connection cable and communication port setup.
UAr	Spurious host PC comm interrupt	Regulator board failure.	Replace Regulator board.
UbS	Asymmetrical bus fault. Look at the 3 LEDs on the Power Module Interface board. They indicate which fault has occurred by flashing in unison. 1 = Input Ground Fault; 2 = Asymmetrical Bus; 3 = Slow Ramp Rate of DC Bus	One of 3 different faults has occurred; 1. Input Ground Fault - Excessive current flowing between any of the three input phases and earth ground. 2. Asymmetrical Bus - When measuring between the cap bank midpoint and the +DC bus and -DC bus, there is a 200 V or greater mismatch. 3. Slow Ramp Rate of DC Bus - DC bus did not change to the full value given time allowed. Can occur only at power-up.	1. Check the connection from the current transformer to the Bus Control board. 2. Replace shorted capacitor, fix loose connection, or replace discharge resistor. 3. Turn on drive. If UbS is displayed, turn drive off and then on again very quickly. If the UbS fault goes away and the DC bus charges, replace the Bus Control board.

6.4.3 Accessing, Reading, and Clearing the Faults in the Error Log

The following procedure shows how to access and clear the error log. Note that you cannot clear a single entry from the error log. The entire log, including all the fault codes and the day and time stamp of each fault, will be cleared simultaneously using this procedure.

Step 1. Press the PROGRAM key.

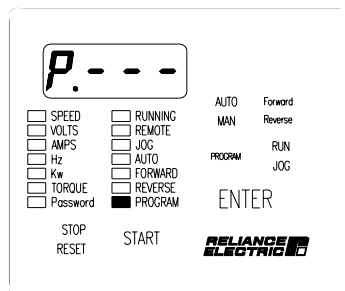

The First Menu General parameters are displayed. The PROGRAM LED will turn on.

Step 2. Press the ▼ key until Err is displayed.

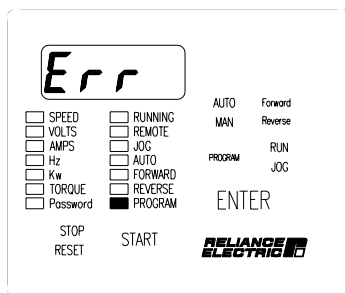

Step 3. Press the ENTER key.

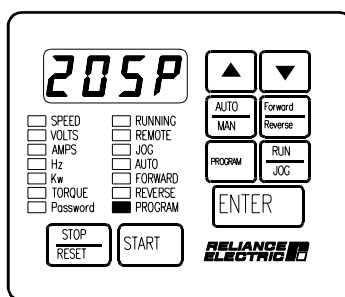

If no faults have occurred, Err will be displayed again. If only one fault has occurred, the fault code will be displayed as the first entry in the log. If more than one fault has occurred, the first entry is the latest fault that occurred.

Step 4. Press the ▲ or the ▼ key. The display steps through the error log entries, which are numbered 0 through 9 (maximum).

Step 5. Press the ENTER key.

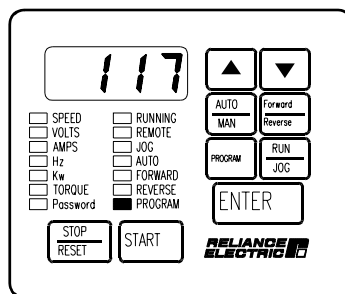

The display shows the day stamp, which can range from 0 to 248 days.

Step 6. Press the ▼ key.



The display shows the time stamp, which is based on a 24-hour clock. Use the arrow keys to move between the day and time data.

Step 7. Press the PROGRAM key, which displays the error log entries again. The display shows the error log entry viewed prior to or associated with the time stamp.

Step 8. Repeat steps 4 through 7 for each additional error log entry to view the time and date for each error log entry.

Step 9. When you have viewed all the entries, you should clear the error log. Press the ▼ key while you are viewing any entry in the log until the display shows CLr. Press ENTER to clear the error log. All entries will be cleared.

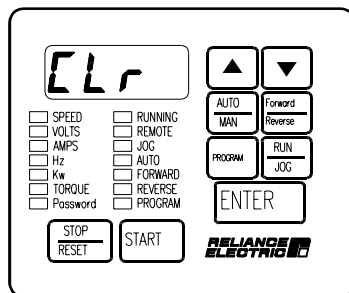

Step 10. Err will be displayed again to indicate that the log is empty.

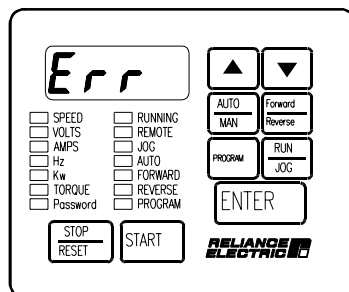

Step 11. Press the PROGRAM key to access monitor mode.

6.5 Identifying Fatal Fault Codes and Recovering

Fatal fault codes are distinguished by the letter F preceding the code. They normally indicate a malfunction of the microprocessor on the Regulator board. In some cases, fatal fault codes can be reset and the drive can be re-started. Table 6.4 lists the fatal fault codes which can be reset. If any other fault code appears on the display, you will need to replace the Regulator board.

If the fault code FUE appears in error log entry 0, it indicates a fatal fault occurred as power was lost. Contact Reliance Electric or observe the drive for subsequent fatal errors before turning off power. Fatal fault codes are lost after power loss.

Table 6.4 – Fatal Fault Codes That Can Be Reset

Code	Fault Description	Fault Cause	Corrective Action
F 3	Encoder power-up diagnostic error.	Encoder voltage is less than 10 V.	<p>Turn off power to the drive. Disconnect the encoder wiring from the terminal strip. Turn power to the drive back on.</p> <p>If the F3 error does not occur again, the problem is in the wiring between the drive and the encoder.</p> <p>If the F3 error does occur again, the problem is in the Regulator board, which should be replaced.</p>
F 60	Option port identification error.	The option board could not be identified by the regulator.	<p>Check the ribbon cable between the Regulator board and the option board.</p> <p>Check the option board's jumper settings.</p> <p>Refer to the appropriate option board instruction manual for more information about the option board.</p>
F 61	Option board power-up diagnostic failure.	Option board has failed one or more power-up diagnostics.	<p>Check the ribbon cable between the Regulator board and the network option board. Replace the option board if necessary.</p> <p>Refer to the appropriate option board instruction manual for more information about the option board.</p>
F 62 or F 26	Option board runtime error.	During operation, the option board watchdog failed or handshaking with the drive failed.	<p>If intermittent, check for causes of noise, for proper grounding, and that outputs are not exceeding rated current capacities.</p> <p>Replace the option board if necessary. Refer to the appropriate option board instruction manual for more information about the option board.</p>

6.6 Identifying PMC Board Fault Codes and Recovering



ATTENTION: Viewing the PMC board LEDs requires electrical circuits to be exposed. Stay clear if unit must be running. Disconnect and lock out or tag power source if contact must be made. Failure to observe this precaution could result in severe bodily injury or loss of life.

Table 6.5 lists PMC board fault codes. These faults can be identified using the three LEDs located on the Regulator board.

Table 6.5 – PMC Board Fault Codes

Status of LEDs 1-3	Fault Description	Corrective Action
LEDs 1-3 all on.	Normal operation (60 Hz, 50% duty); no fault.	None required.
LEDs 1-3 all off.	VAC_LINE = 'lo'	None required. The board will recover when the line becomes present.
LEDs 1-3 flash in a 3-flash sequence.	VDC_CHG = 'lo'	Reset board.
LEDs 1-3 flash in a 2-flash sequence.	ASYM_FAULT = 'lo'	Reset board.
LEDs 1-3 flash in a 1-flash sequence.	ACGNDFLT = 'lo'	Reset board. (This circuit was removed on the 350 HP assembly.)

6.7 Resetting a Checksum (CHS) Fault

Perform the following procedure when a new Regulator board is installed or if a CHS fault repeats.

Step 1. Press and hold STOPIRESET, PROGRAM, and DOWN ARROW for 5 to 10 seconds. A PUn error should appear.

Step 2. Press PROGRAM. P--- is displayed.

Step 3. Press ENTER. P.000 is displayed.

Perform steps 4 through 7 if access to the second menu has not already been enabled.

Step 4. Press UP ARROW until P.006 is displayed.

Step 5. Press ENTER.

Step 6. Press UP ARROW until 107 is displayed.

Step 7. Press ENTER.

Perform steps 8 through 11 if changing modes of operation (V/Hz or Vec). Otherwise, skip to step 12.

- Step 8. Press UP ARROW until P.048 is displayed.
- Step 9. Press ENTER.
- Step 10. Press UP or DOWN ARROW to select UEC or U-H mode.
- Step 11. Press ENTER. Observe SELF is displayed briefly.
- Step 12. Press UP or DOWN ARROW until P.006 is displayed.
- Step 13. Press ENTER.
- Step 14. Press UP ARROW until 75 is displayed.
- Step 15. Press ENTER.
- Step 16. Press UP ARROW until R998 is displayed.
- Step 17. Press ENTER.
- Step 18. Press UP ARROW until ON is displayed.
- Step 19. Press ENTER.
- Step 20. Press UP ARROW until P.999 is displayed. Depending on software version, the display may show PUGH or P.999.

If PUCH is displayed, wait for 0 to display. The procedure is complete.

If P.999 is displayed, continue with step 21.

- Step 21. Press ENTER.
- Step 22. Press UP ARROW until the correct power unit current and voltage rating code appears. The codes are as follows:

Model Number	Amps	Code
41LR4060	414	41.4
50LR4060	500	50.4
64LR4060	643	64.4

- Step 23. Press ENTER. PUCH should appear briefly.

The drive is ready to operate. If in vector mode, enter the correct values for U parameters and perform SELF TUNING.

Documentation Improvement Form

Use this form to give us your comments concerning this publication or to report an error that you have found. For convenience, you may attach copies of the pages with your comments. After you have completed this form, please return it to:

Rockwell Automation / Reliance Electric Drives
 Technical Documentation
 6040 Ponders Court
 Greenville, SC 29607

Fax: 864-284-5483

Publication Name: LiquiFlo 1.5 AC Drive, Hardware Reference Version 1.2	
Publication Number: D2-3466-2	Publication Date: May 2005

Comments: _____

Your Name:	Date:
Company Name:	Phone: ()
Address:	

Thank you for your comments.

Technical Writing Internal Use	
Date:	DIF Number:
Follow-Up Action: _____	

Rockwell
Automation

www.rockwellautomation.com

Motors, Drives and Power Transmission Solutions

Americas: Rockwell Automation, 6040 Ponders Court, Greenville, SC 29615-4617 USA, Tel: (1) 864.297.4800, Fax: (1) 864.281.2433

Europe/Middle East/Africa: Rockwell Automation, Herman-Heinrich-Gossen-Strasse 3, 50858 Köln, Germany, Tel: 49 (0) 2234 379410, Fax: 49 (0) 2234 3794164

Asia Pacific: Rockwell Automation, 55 Newton Road, #11-01/02 Revenue House, Singapore 307987, Tel: (65) 6356 9077, Fax: (65) 6356 9011

Publication D2-3466-2 - May 2005 -- Supersedes D2-3466-1 - June 2002

Copyright ©2005 Rockwell Automation, Inc. All Rights Reserved. Printed in USA.