

NOTE

- (1) DIMENSIONS (L), (W), (H), ARE FOR STANDARD MACHINE. THE DIMENSIONS ARE CHANGED BY PARTS ADDED.
- (2) ⊕ INDICATES THE POSITION OF ANCHOR BOLTS.
- (3) ALL EXTERNAL WATER & GAS PIPING ARE TO BE PROVIDED WITH WELDED ANSI 150LB FLANGES BY THE CUSTOMER.
- (4) ⚡ INDICATES THE POSITION OF THE POWER SUPPLY CONNECTION ON CONTROL PANEL. (DIA 2 inch)
- (5) INSTALLATION CLEARANCE
 ·LONGITUDINAL DISTANCE:40 inch
 ·TOP :8 inch
 ·OTHERS:20 inch
- (6) FLUE CONNECTION
 THE FLUE OUTLET IS FEMALE.
 THE CONNECTION SIZE IS THE INSIDE DIAMETER.

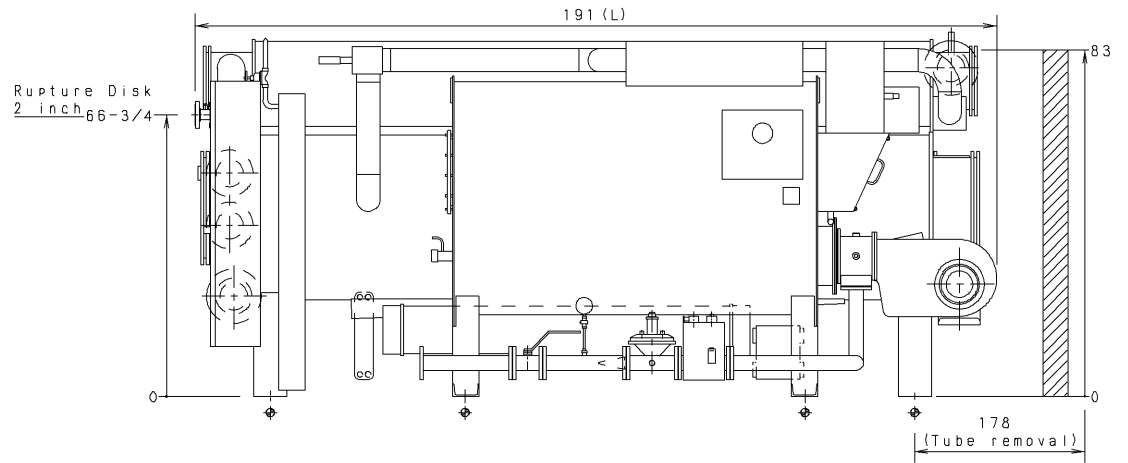
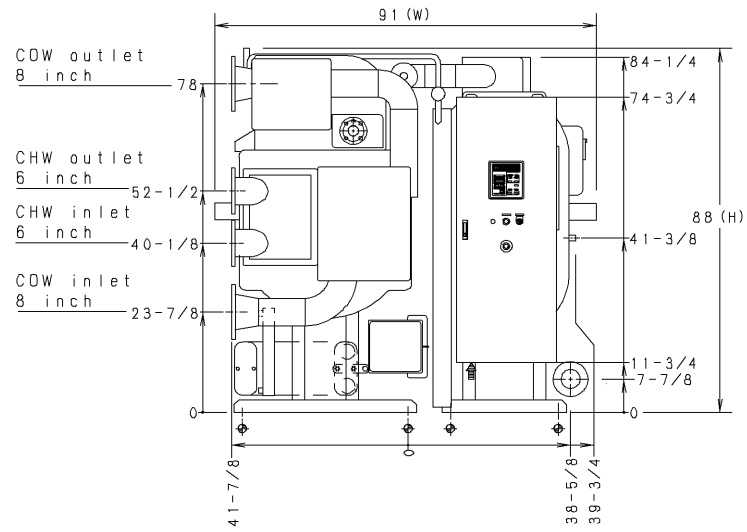
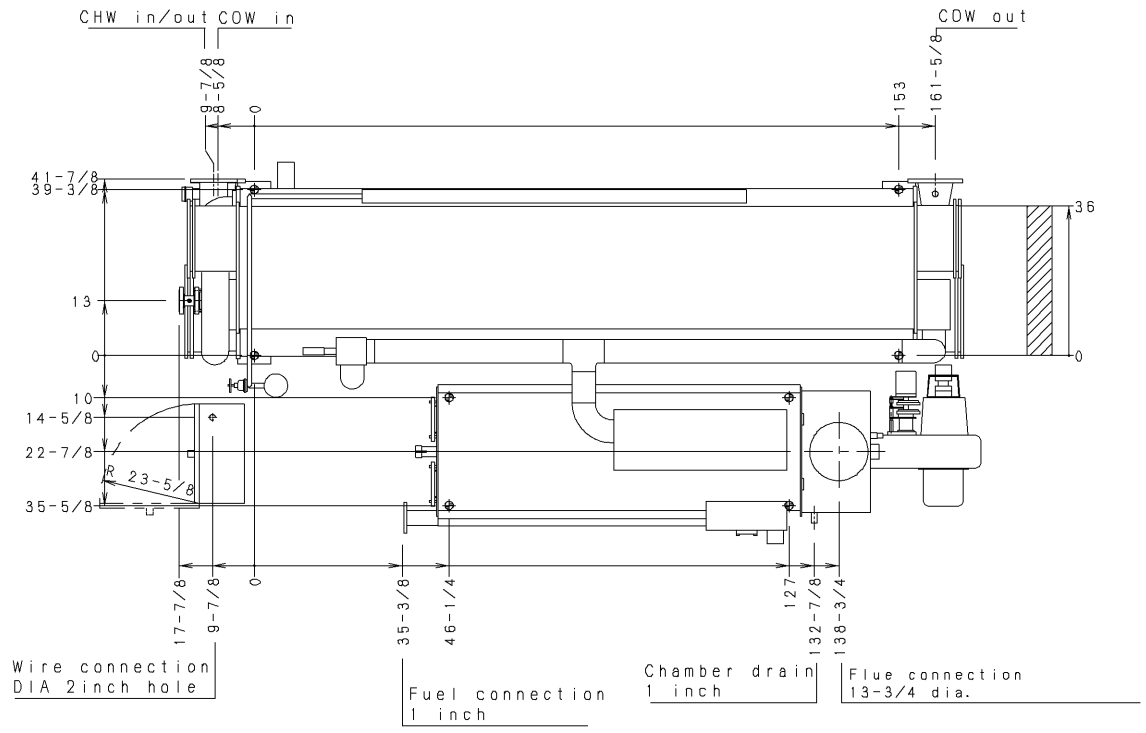

E2 A2 C1 Gas 1"

Carrier
SANYO

DIMENSIONS

TSA-16DJ-24

DJ-006-508-00-5