

GAPAB
Infinity™ Air Purifier for Fan Coils
Sizes 1620, 2020, and 2420

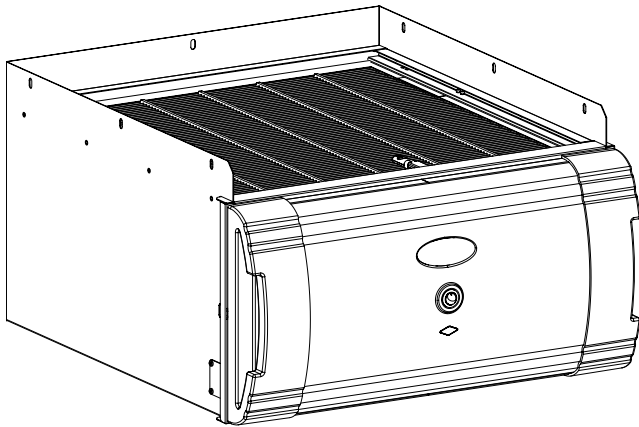

Turn to the Experts™

Product Data



A06377

INFINITY™ SERIES



The Infinity™ Air Purifier is designed for use in the return air duct of a forced air heating, cooling, and ventilation system. Models GAPABXCC1620, GAPABXCC2020 and GAPABXCC2420 are specifically designed for use in systems with a forced air fan coil and are intended to be powered by 208/230v-60 Hz.

The Infinity™ Air Purifier both captures and kills airborne viruses, bacteria, mold spores, and allergens. It combines superior filtration efficiency, equivalent to MERV 15, with pathogen-killing technology to deliver maximum air purification.

The Infinity™ Air Purifier is designed to require minimal maintenance. Maintenance is limited to the replacement of the air purification cartridge and inspection/brush cleaning of the ionization array. Frequency of air purifier cartridge replacement and cleaning of the ionization array may vary depending on ductwork design and local environmental conditions.

FEATURES/BENEFITS

Performance—Ultra-high efficiency equivalent to MERV 15. Captures and kills airborne viruses, bacteria, and mold spores.

Simple—Virtually no cleaning required. Simply change purifier cartridge periodically.

Easy to Install—Three distinct cabinet sizes help to ensure a perfect fit to the bottom and side of most Carrier fan coils.

Application Possibilities—Unit can be installed in a horizontal or vertical position, which makes it equally adaptable to horizontal, downflow, or standard upflow applications.

Solid-State Power Supply—Power supply is a highly reliable state-of-the-art, solid-state, high-voltage device.

Durable Cabinet—Heavy-gage steel cabinet supports up to 400 lb when installed beneath a fan coil.

Agency Listed—Model GAPAB Air Purifier is CSA (Canada and US) listed.

Financing—Eligible for consumer financing program.

Limited Warranty—

- 5-year warranty on the unit with a \$25 labor allowance for service calls within the first 120 days after installation.
- 5-year warranty on power supply with \$50 labor allowance, within the first 120 days after installation.

SPECIFICATIONS AND DIMENSIONS

Specifications	GAPABXCC1620	GAPABXCC2020	GAPABXCC2420
Color	Taupe Metallic	Taupe Metallic	Taupe Metallic
Cabinet Material	20 Ga. Powder Coated Steel	20 Ga. Powder Coated Steel	20 Ga. Powder Coated Steel
Electrical	208/230v/60Hz	208/230v/60Hz	208/230v/60Hz
Maximum Airflow (CFM)	1350	1800	2000
Efficiency	Equivalent to MERV 15	Equivalent to MERV 15	Equivalent to MERV 15
Replacement Cartridge	GAPCCCAR1620	GAPCCCAR2020	GAPCCCAR2420
Initial Pressure Drop (in w.c.) (at maximum airflow)	.22	.25	.22

Dimensions	GAPABXCC1620	GAPABXCC2020	GAPABXCC2420
A	18-1/2	22	25-1/2
B	15-1/8	18-5/8	22-1/8
C	13-1/8	13-1/8	13-1/8
D	17-5/8	21-1/8	24-5/8
E	19-3/4	19-3/4	19-3/4
F	22-1/4	22-1/4	22-1/4
G	11-1/4	11-1/4	11-1/4

PRESSURE DROP AT VARIOUS INTERVALS (CLEAN)

Airflow (CFM)	Resistance (inches of water) (Clean filter)		
	Typical 16 X 20	Typical 20 X 20	Typical 24 X 20
400	0.04	0.035	0.03
600	0.07	0.06	0.05
800	0.10	0.08	0.07
1200	0.18	0.14	0.11
1400	0.23	0.17	0.14
1600	--	0.21	0.16
1800	--	0.25	0.19
2000	--	--	0.22

NOTE: When applying the GAPAB Infinity™ Air Purifier, attention must be given to the duct and system design because all these components affect system static pressure. The GAPAB Infinity™ Air Purifier has a higher static pressure drop than the typical factory supplied furnace and/or fan coil filter (as shown above), but is designed to ensure proper system efficiency and reliability when applied to a properly designed duct system and properly sized HVAC equipment.

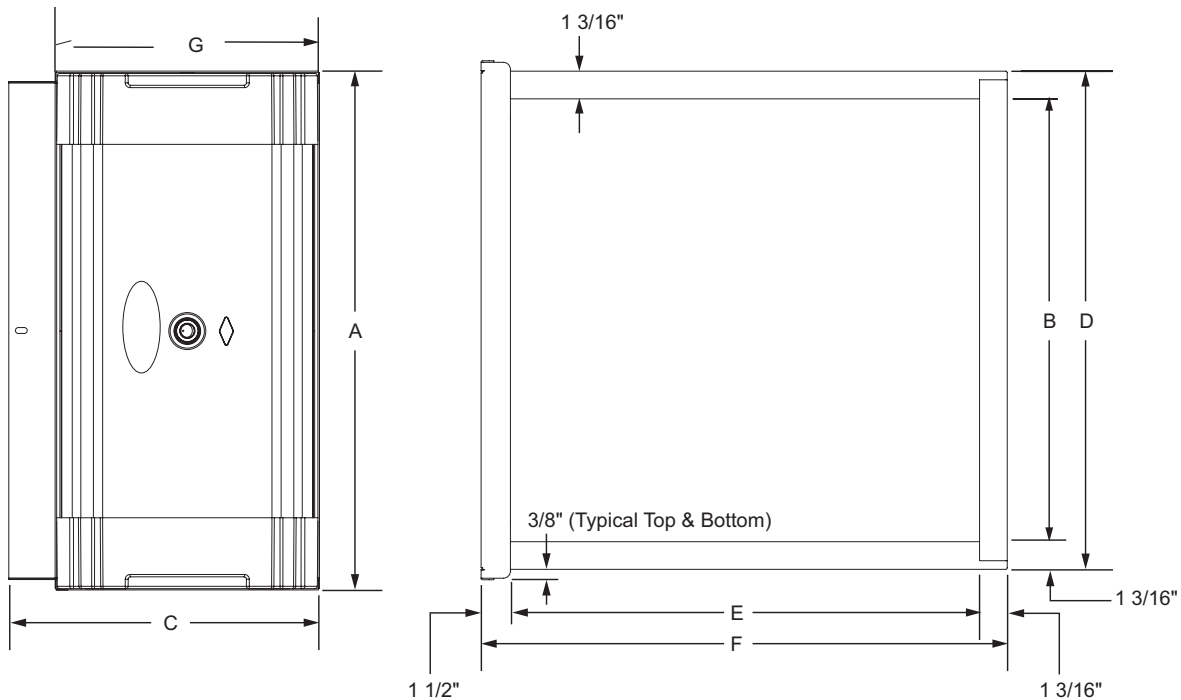

A06378