



NOTE

- (1) DIMENSIONS (L), (W), (H), ARE FOR STANDARD MACHINE. THE DIMENSIONS ARE CHANGED BY PARTS ADDED.
- (2)  INDICATES THE POSITION OF ANCHOR BOLTS.
- (3) CLEARANCE SPACE MUST BE SAVED EITHER SIDE OF THE CHILLER.
- (4) ALL EXTERNAL WATER PIPING ARE TO BE PROVIDED WITH WELDED ANSI 150LB FLANGES BY THE CUSTOMER.
- (5)  INDICATES THE POSITION OF THE POWER SUPPLY CONNECTION ON CONTROL PANEL. (DIA. 1-3/8 inch)
- (6) INSTALLATION CLEARANCE
  - LONGITUDINAL DISTANCE:40inch
  - TDP :8inch
  - OTHERS:20inch

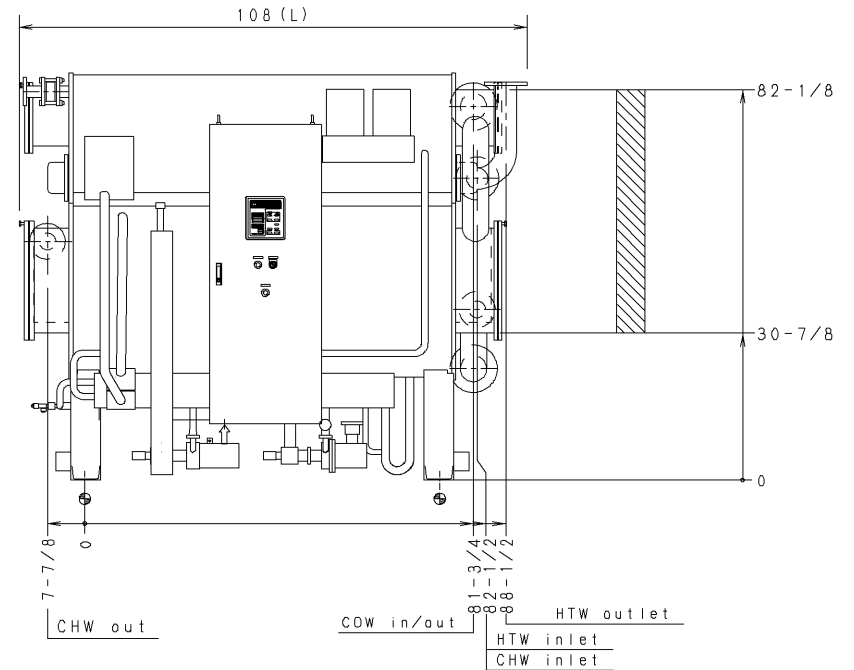
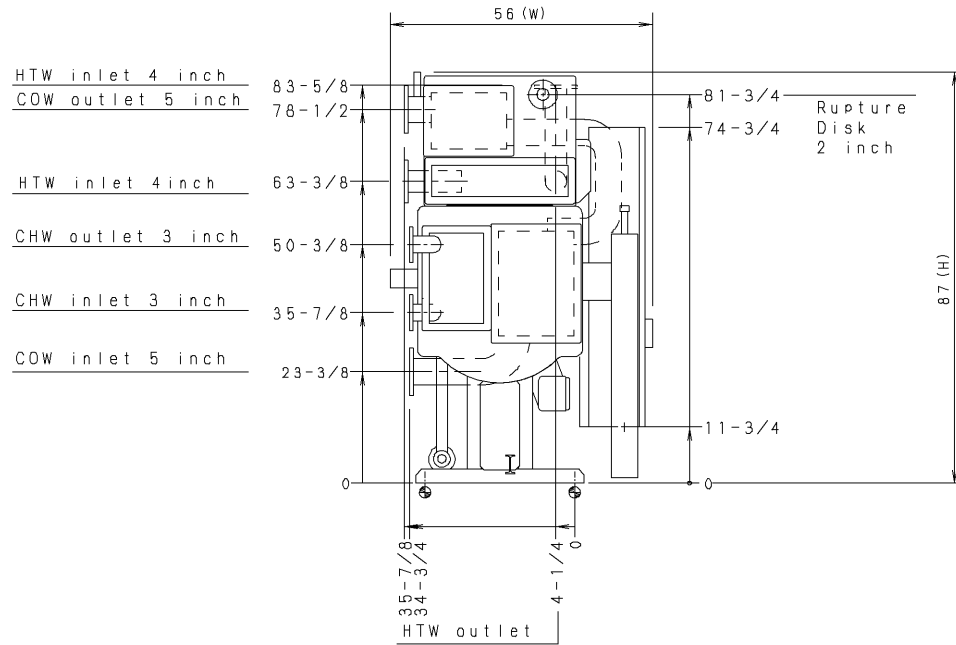
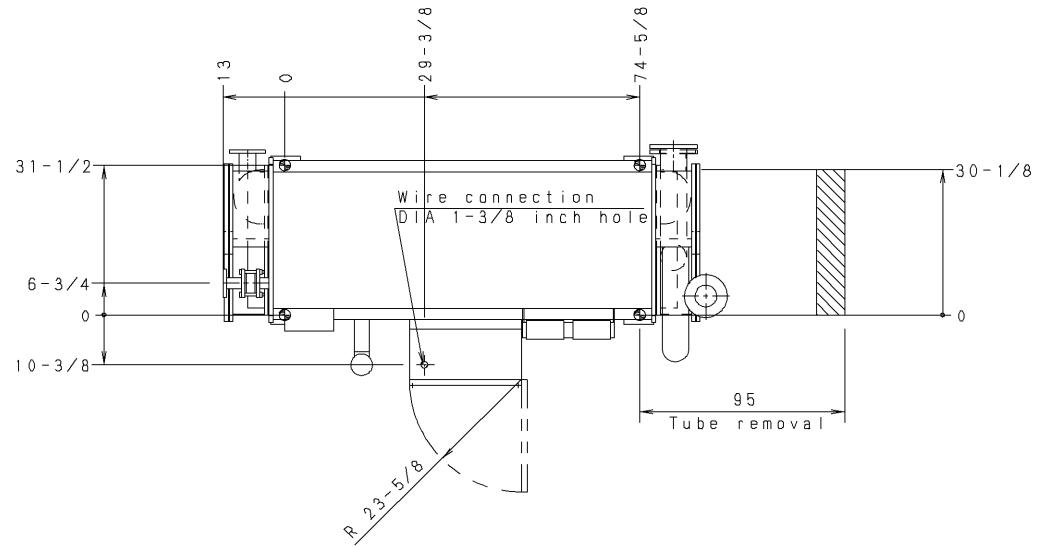

E5 A4 C2 G6

**Carrier**  
**SANYO**

DIMENSIONS

TSA-16LJ-11

LJ-006-501-00-3