



NOTE

- (1) DIMENSIONS (L), (W), (H), ARE FOR STANDARD MACHINE. THE DIMENSIONS ARE CHANGED BY PARTS ADDED.
- (2)  INDICATES THE POSITION OF ANCHOR BOLTS.
- (3) CLEARANCE SPACE MUST BE SAVED EITHER SIDE OF THE CHILLER WITH WELDED ANSI 150LB FLANGES BY THE CUSTOMER.
- (4) ALL EXTERNAL WATER PIPING ARE TO BE PROVIDED WITH WELDED ANSI 150LB FLANGES BY THE CUSTOMER.
- (5)  INDICATES THE POSITION OF THE POWER SUPPLY CONNECTION ON CONTROL PANEL. (DIA. 1-3/8 inch)
- (6) INSTALLATION CLEARANCE
 - LONGITUDINAL DISTANCE:40 inch
 - TOP :8 inch
 - OTHERS:20 inch

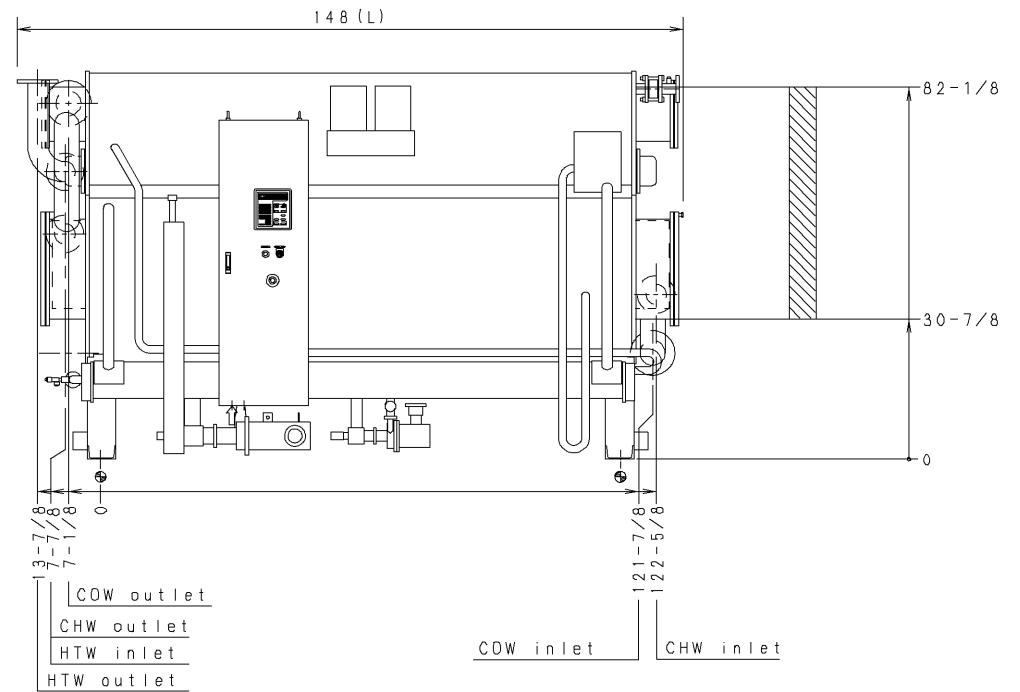
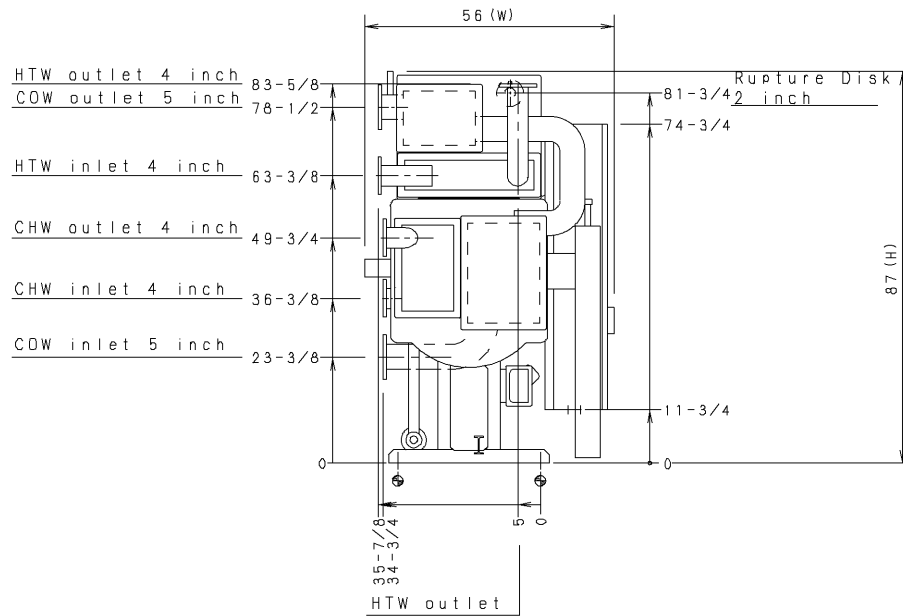
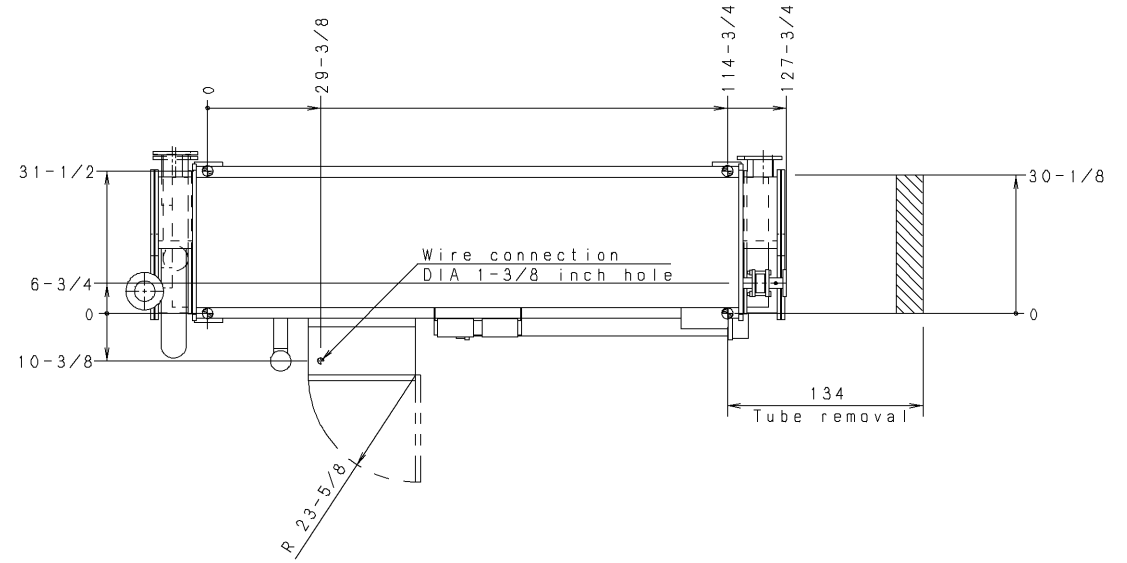

E3 A3 C2 G4

Carrier
SANYO

DIMENSIONS

TSA-16LJ-14

LJ-006-504-00-4