

Note)

- 1) indicates the machine base.
The machine base has a 2 in. diameter hole for the anchor bolt.
- 2) The anchor bolt should be fixed as shown in the detail drawing.
The washer should be welded to the base (see detail drawing)
- 3) There should be a drain channel around the foundation.
- 4) The floor surface should be made waterproof to facilitate maintenance work.
- 5) The surface of the foundation should be made flat.
(Leveling tolerance is less than 1/4 in. per 20 ft.)
- 6) Anchor bolts and nuts are to be supplied by the customer.

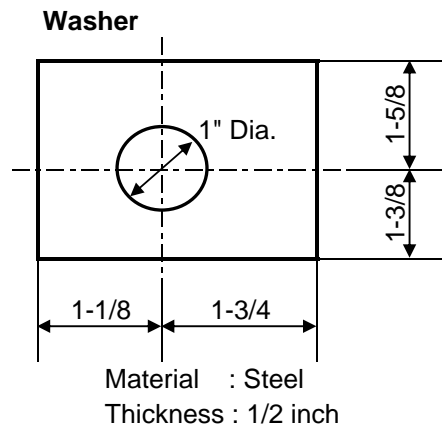
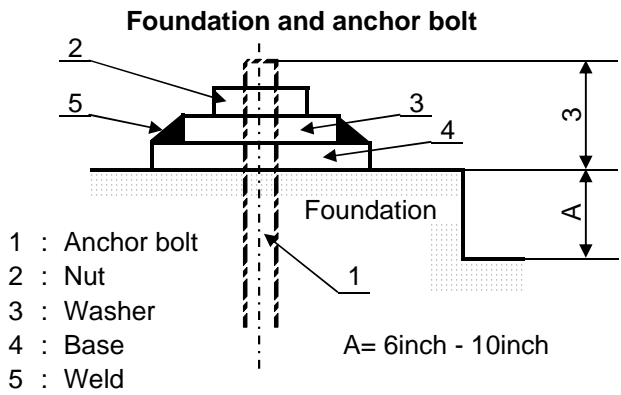

Foundation

Model

TSA-16LJ-12

Drawing code

LJ-012-502-00-4