

Note)

- 1)  indicates the machine base.  
The machine base has a 2 in. diameter hole for the anchor bolt.
- 2) The anchor bolt should be fixed as shown in the detail drawing.  
The washer should be welded to the base (see detail drawing)
- 3) There should be a drain channel around the foundation.
- 4) The floor surface should be made waterproof to facilitate maintenance work.
- 5) The surface of the foundation should be made flat.  
(Leveling tolerance is less than 1/4 in. per 20 ft.)
- 6) Anchor bolts and nuts are to be supplied by the customer.

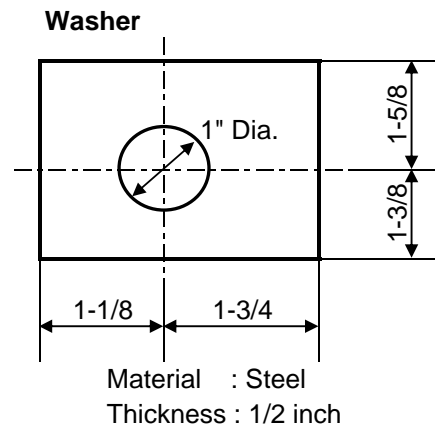
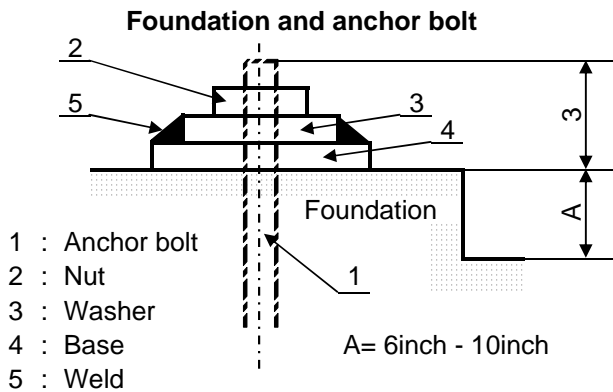

**Carrier**  
**SANYO**

**Foundation**

Model

**TSA-16LJ-42**

Drawing code

**LJ-012-512-00-4**