

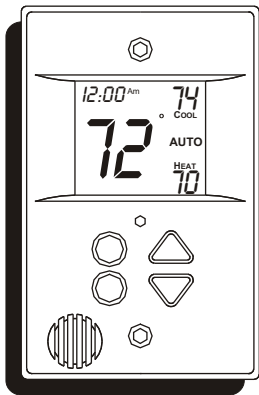

TSTATCCPF101 PROGRAMMABLE

DIGITAL THERMOSTAT

USER INFORMATION MANUAL FOR THE OPERATION AND MAINTENANCE OF YOUR NEW THERMOSTAT



• Heat Pump & Heat Cool

PROGRAMMABLE DIGITAL THERMOSTAT

- Mounts Flush to the Wall
- 1 Day Programmable or Non-Programmable
- 4 Time Periods per Day
- Auto Changeover
- Large, Easy To Read Display
- Thermoglow Backlight
- Dual or Single Setpoint
- No Batteries Required
- Outdoor Temperature Sensor Available

• Meets California Title 24 Residential

NOTE TO INSTALLER: THIS MANUAL MUST BE LEFT WITH THE EQUIPMENT USER.

Table Of Contents

FRONT PANEL	2
DISPLAY	3
QUICK START <i>Set the clock and go</i>	5
BASIC OPERATION	6
PROGRAMMING <i>4 Time Periods</i>	8
ADVANCED SETUP	11
ABOUT ADVANCED OPERATION	15
WARRANTY	20



CAUTION

Follow *Installation Instructions* before proceeding.

SET THERMOSTAT TO MODE "OFF" PRIOR TO
CHANGING SETTINGS IN SETUP OR RESTORING
FACTORY DEFAULTS.

Residential Light Commercial Systems © Carrier Corporation 4/01

TSTATCCPF101

Front Panel

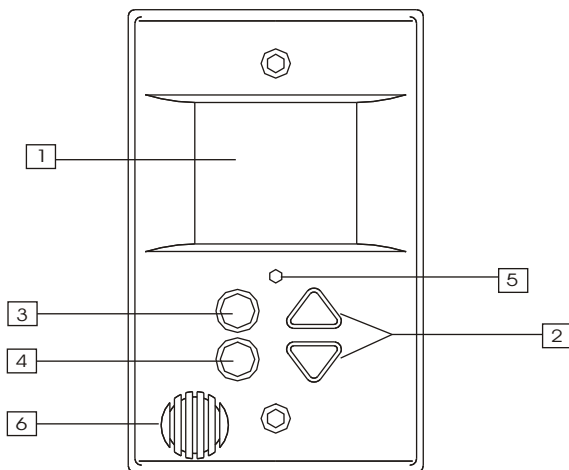

- 1** **Liquid Crystal Display**
with Thermoglow™
- 2** **Up/Down Buttons**
- 3** **Mode Button**
- 4** **Fan Button**
- 5** **Heat or Cool Indicator**
Heat = Red, Cool = Green
- 6** **Temperature Sensor Bubble**

Display

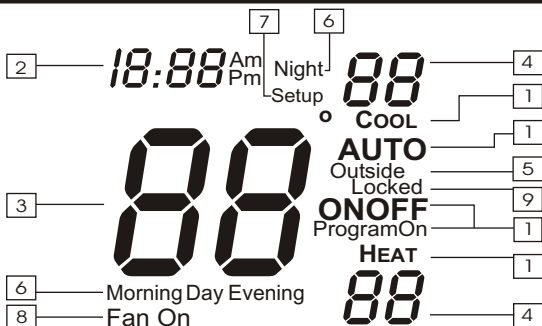

1 Mode Indicators

Selects the operation mode of the equipment.

HEAT - indicates the heat mode.

COOL - indicates the air conditioning mode.

AUTO - indicates the system will automatically changeover between heat and cool modes as the temperature varies.

OFF - indicates the entire system is turned off.

PROGRAM ON - indicates the stored program is enabled to run. *Page 6.*

2 Clock

Indicates the current time of day. This clock is also used to program the timer periods. *Page 5.*

3 Room Temperature Display

Indicates the current room temperature. When the degree icon is flashing the display indicates the outside temperature.

4 Desired Set Temperature

Indicates desired room temperature(s). *Page 7.*

- 5 **Outside** Indication
Indicates the temperature displayed is from the optional outside sensor. *Page 19.*
- 6 **Morning, Day, Evening & Night** Indication
Indicates the program time period. *Page 8-10.*
- 7 **Setup** Indication
Indicates the thermostat is in the Advanced Setup mode. *Page 11.*
- 8 Fan Operation Indication
Fan On - indicates constant, continuous fan operation.
When **Fan On** is not lit - indicates the fan will only operate when necessary to heat or to cool. *Page 7.*
- 9 **Locked** Indication
Locked appears after the right combination of buttons are pressed, rendering the buttons inoperative. *Page 17.*

Quick Start *Set the Clock and Go*

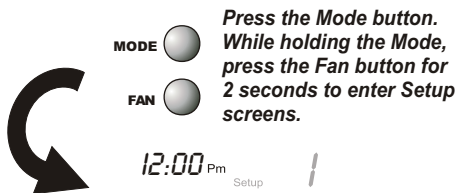

Pressing the Up and Down buttons will modify the flashing selection.

Press both Mode and Fan buttons as above to return to normal operation.



The thermostat is preprogrammed from the factory to operate 1 or 2 Stage equipment* without the need for further programming. To optimize the installation of this thermostat follow the instructions in the Advanced Setup section.

** The thermostat is not preprogrammed from the factory to operate electric heat or heat pump systems. To control these systems, follow the steps in the Advanced Setup section, page 12.*

Basic Operation

Select Mode

The **HEAT** setting indicates the temperature the room has to reach before the furnace will turn on to heat the room.

The **COOL** setting indicates the temperature the room has to reach before the air conditioner will turn on to cool the room.

AUTO will automatically select heat or cool based on room temperature demand.

Program On will activate the stored timer operation.
(Morning, Day, Evening & Night periods.)

OFF indicates both heating and air conditioning systems are turned off.

12:00 Pm

70°

HEAT
69

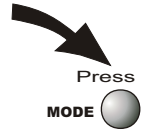

12:00 Pm

70°

72
COOL



12:00 Pm

70°

72
COOL

AUTO

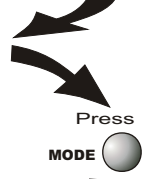

12:00 Pm Night

70°
Program On

73
COOL

HEAT
70



12:00 Pm

70°

OFF



Basic Operation

Select Desired Temperature

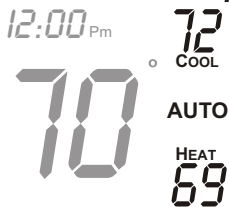

In any mode, adjust the desired Set Temperature with



buttons.

Pressing the Up or Down buttons in Auto mode will adjust **both** the heat and cool set temperatures simultaneously.

Pressing the Up or Down buttons in Heat or Cool modes will adjust only the Heat or Cool set temperature.

To select desired temperature in *Single Setpoint*, please also refer to *page 17*.

Fan Operation



Fan On indicates constant fan operation. This feature is active even if the thermostat is set to **Off**.

Programming

4 Time Periods

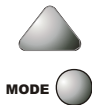

Press the Mode button. While holding the Mode, press the Up button for 2 seconds to enter time period programming.

IMPORTANT NOTE: If the thermostat is configured for single setpoint operation, there will be a prompt to enter only one setpoint.



Adjust the start time for Morning.

7:30 Am

Morning



Adjust the cooling setpoint for Morning.
(35 - 99°)

7:30 Am

74
COOL

Morning



Adjust the heating setpoint for Morning.
(35 - 99°)

7:30 Am

74
COOL

Morning

HEAT
72

Continued

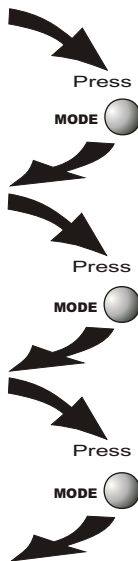

Programming

4 Time Periods



Adjust the start time
for Day.

10:30^{Am}

Day

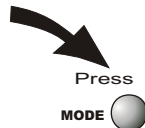

Adjust the cooling
setpoint for Day.
(35 - 99°)

10:30^{Am}

Day

75
COOL

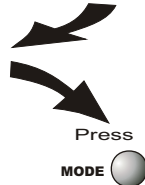

Adjust the heating
setpoint for Day.
(35 - 99°)

10:30^{Am}

Day

75
COOL

HEAT
73



Adjust the start time
for Evening.

5:30^{Pm}

Evening

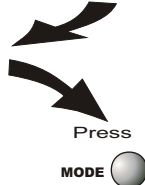

Adjust the cooling
setpoint for Evening.
(35 - 99°)

5:30^{Pm}

Evening

75
COOL

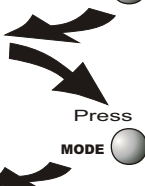

Continued

Programming

4 Time Periods



Adjust the heating
setpoint for Evening.
(35 - 99°)

5:30 Pm

75
COOL

Evening
HEAT
73

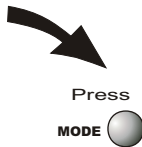

Press

MODE



Adjust the start time
for Night.

11:30 Pm Night



Press

MODE



Adjust the cooling
setpoint for Night.
(35 - 99°)

11:30 Pm Night

78
COOL



Press

MODE



Adjust the heating
setpoint for
(35 - 99°)

11:30 Pm Night

78
COOL



Press

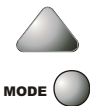

MODE



Press the Mode button. While holding the Mode, press the Up button to exit time period programming.



Advanced Setup

MODE  **Press the Mode button.**
FAN  **While holding the Mode, press the Fan button for 10 seconds to enter Setup screens.**

NOTE: Each step # is located at the top right corner of the display for easy reference.



Adjust the time of day clock.

Tip: To change hours quickly, press and hold the Fan button in and press the up or down buttons.



On

Select 1-Day Programmable (ON) or Non-Programmable (OFF)

Off



Select Single setpoint or Dual setpoint operation.
1 = Single Setpoint
2 = Dual Setpoint

12:00^{Am}
Setup

1

Press

MODE 

Setup 2

ON
Program

Press

MODE 

dSP Setup 3

2

Press

MODE 

Continued

Advanced Setup

On
Select residential Heat Pump, On or Off.
Off

Setup 4
HP
OFF

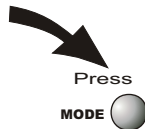

B
Select the reversing valve polarity for Heat Pump, O or B.
(Step 5 only appears if heat pump is on in step 4)
O

Setup 5
0



On
Select Electric Heat On or Off. (Step 6 only appears if heat pump is off in step 4)
Off

Setup 6
EH
OFF



Adjust the deadband from 1 - 6 degrees.

Setup 7
db
2

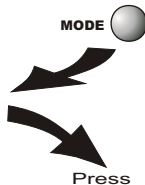

Adjust the minimum **difference** between cooling & heating setpoints.
(0 - 6°)

Setup 8
dif
COOL
2
HEAT

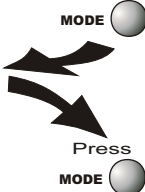

Continued

Advanced Setup



Select the cycles per hour limit.
d=cycles per hour limit defeated.
d1=d + defeat 5 min.
Compressor lockout.

(d, d1, 2 - 6)

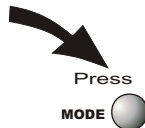

On
Select the display back-light always **On**, or **Off** after 8 seconds.
Off

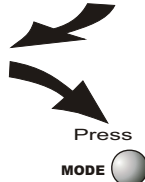

C
Select thermostat operation in degrees Fahrenheit or Centigrade.
F



*Press the Mode button.
While holding the Mode, press the Fan button for 2 seconds to leave the Setup screens. If no buttons are pressed, the display will leave the setup screens after 60 seconds.*

Advanced Setup

Advanced Setup Table

Step #	Description	Range	Factory Default
1	Time of day clock set	24 hour	12:00 Am
2	Time Period Programmable	Off / On	On
3	Display Mode	1 / 2	2
4	Heat Pump	Off / On	Off
5	Reversing Valve polarity	O / B	O
6	Electric Heat	Off / On	Off
7	Deadband or Temperature swing	1 - 6	1
8	Forced minimum difference heat/cool	0 - 6	2
9	Cycles per hour	d, d1, 2 - 6	6
10	Thermoglow backlight	Off / On	On
11	Fahrenheit or Centigrade	F / C	F

About Advanced Features & Operation

- * MEMORY BACKUP - In the event of a power loss, the thermostat will retain the stored program settings without external power or batteries.
- * 2 STAGE OPERATION - The 2nd Stage of heat or cool is turned on when (1) the 1st Stage has been on for a minimum of two minutes, **and** (2) the temperature spread from the setpoint is equal to or greater than: *the setpoint plus the deadband, plus 2 degrees.*

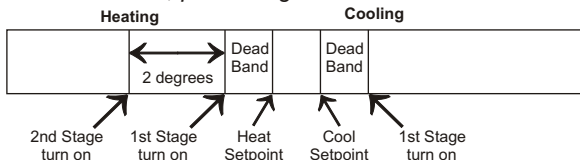

- * MINIMUM HEAT/COOL SETPOINT DIFFERENCE - The Heat and Cool setpoints will not be allowed to come any closer to each other than the value set in Advanced Setup *step # 8, on page 12*. This minimum difference is enforced during Auto changeover and Program On operation.

About Advanced Features & Operation

- * **EMERGENCY HEAT** - Is a feature available to Heat Pump installations. To turn on Emergency Heat press in the Fan button. While holding the Fan button press the Up button for 2 seconds. The Cool setpoint display will read 'EH'.

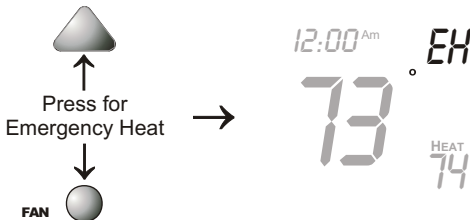

During Emergency Heat the thermostat will turn on the fan and the 2nd stage of heat, when there is a demand for heat, locking out the 1st stage compressor. Exiting Emergency Heat is the same as entering. During Emergency Heat only OFF and HEAT are available.

- * **ELECTRIC HEAT** - Selecting Electric Heat on, *page 12, step 6*, will cause the thermostat to turn on the fan immediately any time there is a heat demand. Since all gas furnaces control the fan, this feature should be off unless the heater is only electric.

About Advanced Features & Operation

- * **KEYPAD LOCK** - To prevent unauthorized use of the thermostat, the front panel buttons may be disabled. To disable, or 'lock' the keypad, press and hold in the Mode button. While holding the Mode button in, press the Up and Down buttons in together. The **Locked** icon will appear on the display.

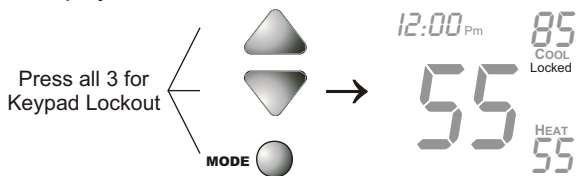

To **unlock** the buttons, again press and hold the Mode button. While holding the Mode button in, press the Up and Down buttons in together. The **Locked** icon will disappear from the display.

- * **SINGLE SETPOINT BEHAVIOR** - When configured as a *Single Setpoint* thermostat, *page 11, step 3*, the large number is the setpoint. In Auto mode the deadband is above and below the setpoint. To avoid short cycling in *single setpoint* it is recommended to raise the deadband to a minimum of 2, *page 12, step 7*.

Press and hold the Mode button for 2 seconds to display the room temperature. Press any button to return to normal display.

Press and hold the Fan button for 2 seconds to display the outside temperature, if an optional outdoor sensor is connected. *Also see page 19.*

About Advanced Features & Operation

- * DUAL SETPOINT BEHAVIOR - The adjustable setpoint range is: 35 - 99 degrees in Fahrenheit and 7 - 35 degrees in Centigrade. When in the modes Heat or Cool, this adjustable range is unhampered.

When adjusting any Auto mode, including programming 4 Time periods, the thermostat will not allow the Heat setpoint to get closer to the Cool setpoint than the value programmed as the minimum difference in *step 8, page 12*.

When entering the Auto mode from Cool, the Heat and Cool setpoints will remain spread apart by the amount that they were adjusted, prior to entering Auto.

For example: If the Cool setpoint was set to 80 while in the Cool mode and the Heat setpoint was adjusted to 70 while in the Heat mode, upon entering the Auto mode the Heat and Cool setpoints would be 80 and 70. **Both** setpoints would then move up and down together, (in this example spread by 10 degrees), by pressing the up or down buttons.

To move the Heat and Cool setpoints closer together, enter the Cool or Heat mode by pressing the Mode button, then adjust the setpoint(s) closer together. Heat is limited to how close it can come to Cool by *step 8, page 12*.

About Advanced Features & Operation

- * **OUTSIDE SENSOR (Optional Accessory)** - When connected to terminals RS+5, RS, & GND on the back of the thermostat, the thermostat will read the temperature from the Outside Sensor when asked to. This thermostat will not control to this sensor, it is only to read outside temperature.

To read the temperature from the Outside Sensor, press and hold the Fan button for 2 seconds. The display will then only show Outside temperature. Pressing any button will then return the display to normal operation.

The Outside Sensor is available in a wired or wireless version. The wired sensor can be connected to the thermostat with **up to 500' of 20 ga. or 300' of 18 ga. Unshielded, thermostat wire.**

See the Outside Sensor instructions for further details.

- * **FACTORY DEFAULTS** - If, for any reason it is desirable to return all stored settings back to the factory default settings, press the Mode button. While holding the Mode button in, press the Down button for 2 sec. All icons will appear. Press and hold in the Fan button until **Fd** appears. This resets all factory settings. **To calibrate room temperature**, press the Mode button once more. At this point use the Up and Down buttons to calibrate room temperature, if needed. Press the Mode button to return to normal operation. **NOTE CAUTION ON PAGE 1.**

Warranty

Five-Year Warranty - This Product is warranted to be free from defects in material and workmanship. If defect appears within five years from the date of original installation, whether or not actual use begins on that date, then the product does meet this warranty. A new or remanufactured part, at the manufacturer's sole option, to replace any defective part will be provided without charge for the part itself; PROVIDED the defective part is returned to the distributor through a qualified servicing dealer.

THIS WARRANTY DOES NOT INCLUDE LABOR OR OTHER COSTS incurred for diagnosing, repairing, removing, installing, shipping, servicing or handling of either defective parts or replacement parts. Such costs may be covered by a separate warranty provided by the installer.

THIS WARRANTY APPLIES ONLY TO PRODUCTS IN THEIR ORIGINAL INSTALLATION LOCATION AND BECOMES VOID UPON REINSTALLATION.

LIMITATIONS OF WARRANTIES – ALL IMPLIED WARRANTIES (INCLUDING IMPLIED WARRANTIES OF FITNESS FOR A PARTICULAR PURPOSE AND MERCHANTABILITY) ARE HEREBY LIMITED IN DURATION TO THE PERIOD FOR WHICH THE LIMITED WARRANTY IS GIVEN. SOME STATES DO NOT ALLOW LIMITATIONS ON HOW LONG AN IMPLIED WARRANTY LASTS, SO THE ABOVE MAY NOT APPLY TO YOU. THE EXPRESSED WARRANTIES MADE IN THIS WARRANTY ARE EXCLUSIVE AND MANY NOT BE ALTERED, ENLARGED, OR CHANGED BY ANY DISTRIBUTOR, DEALER, OR OTHER PERSON WHATSOEVER.

ALL WORK UNDER THE TERMS OF THIS WARRANTY SHALL BE PERFORMED DURING NORMAL WORKING HOURS. ALL REPLACEMENT PARTS, WHETHER NEW OR REMANUFACTURED, ASSUME AS THEIR WARRANTY PERIOD ONLY THE REMAINING TIME PERIOD OF THIS WARRANTY.

THE MANUFACTURER WILL NOT BE RESPONSIBLE FOR:

1. Normal maintenance as outlined in the installation and servicing instructions or owners manual including filter cleaning and/or replacement and lubrication.
2. Damage or repairs required as a consequence of faulty installation, misapplication, abuse, improper servicing, unauthorized alteration or improper operation.
3. Failure to start due to voltage conditions, blown fuses, open circuit breakers or other damages due to the inadequacy or interruption of electrical service.
4. Damage as a result of floods, winds, fires, lightning, accidents, corrosive environments or other conditions beyond the control of the Manufacturer.
5. Parts not supplied or designated by the Manufacturer, or damages resulting from their use.
6. Manufacturer products installed outside the continental U.S.A., Alaska, Hawaii, and Canada.
7. Electricity or fuel costs or increases in electricity or fuel costs from any reason whatsoever including additional or unusual use of supplemental electric heat.
8. ANY SPECIAL INDIRECT OR CONSEQUENTIAL PROPERTY OR COMMERCIAL DAMAGE OF ANY NATURE WHATSOEVER. Some states do not allow the exclusion of incidental or consequential damages, so the above may not apply to you.

This warranty gives you specific legal rights, and you may also have other rights which may vary from state to state.

P/N 88-317

Form No. OMTSTAT-29
Catalog No. 03TS-TA43