

# Installation Instructions

**NOTE:** Read the entire instruction manual before starting the installation.

## TABLE OF CONTENTS

	PAGE
SAFETY CONSIDERATIONS .....	1
INTRODUCTION .....	2
INSTALLATION AND START-UP OVERVIEW .....	2
INSTALLATION .....	2
INSTALLING INFINITY ZONE CONTROL .....	5
INITIAL POWER-UP .....	6
QUICK START .....	8
INSTALL / SERVICE MENUS .....	9
EQUIPMENT SUMMARY MENU .....	9
INSTALL MENU .....	9
SETUP MENU .....	9
CHECKOUT MENU .....	13
SERVICE MENU .....	14
OPERATIONAL INFORMATION .....	16
TROUBLESHOOTING .....	18
SYSTEM MALFUNCTION SCREEN .....	19

## SAFETY CONSIDERATIONS

Read and follow manufacturer instructions carefully. Follow all local electrical codes during installation. All wiring must conform to local and national electrical codes. Improper wiring or installation may damage the Infinity Zone System.

Recognize safety information. This is the safety-alert symbol . When you see this symbol on the equipment and in the instruction manual, be alert to the potential for personal injury. Understand the signal words DANGER, WARNING, and CAUTION.

These words are used with the safety-alert symbol. DANGER identifies the most serious hazards, which **will** result in severe personal injury or death. WARNING signifies a hazard, which **could** result in personal injury or death. CAUTION is used to identify unsafe practices, which **may** result in minor personal injury or product and property damage. NOTE is used to highlight suggestions which **will** result in enhanced installation, reliability, or operation.

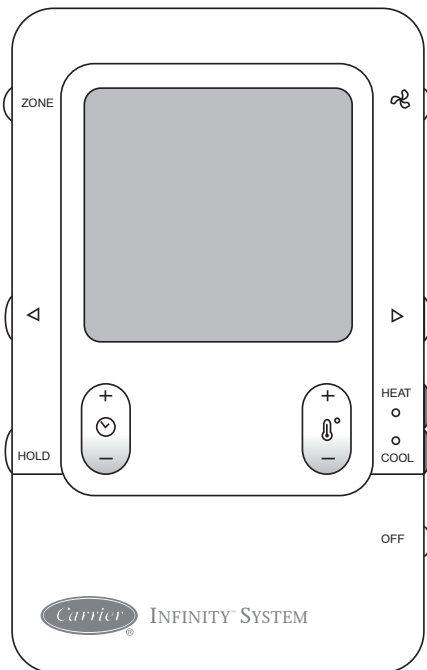

**Fig. 1 - Infinity™ Zone Control**

A04031

## INTRODUCTION

The Infinity Zone System consists of several intelligent communicating components which includes the Infinity Zone Control (or User Interface), Smart Sensors, Damper Control Module, variable speed furnace or FE fan coil, 2-stage AC or HP and Infinity Packaged Products, which continually communicate with each other via a four-wire connection called the ABCD bus. Commands, operating conditions, and other data are passed continually between components over the ABCD bus. The result is a new level of comfort, versatility, and simplicity.

All Infinity furnaces or fan coils are variable-speed and multi-stage for maximum flexibility, efficiency, and comfort. They support controlled ventilation, humidification, dehumidification, and air quality control. Either an Infinity 2-stage (communicating), or a standard 24VAC controlled outdoor unit may be used.

When using conventional outdoor units, the Infinity furnace or fan coil provides the 24 volt signals needed to control them. Also, the Infinity Damper Control Module (P/N SYSTXCC4ZC01) allows connection of a Carrier HRV or ERV without the need for a separate wall control.

All system components are controlled through the wall mounted Infinity Zone Control, which replaces the conventional thermostat and provides the homeowner with a single wall control for all features of the system.

### Design Considerations

The Infinity Zone system is unique because a bypass damper must not be used. This is possible due to the intelligence of the system and variable speed motor technology. For trouble-free applications, the following parameters should always be met:

1. Zones should be sized so that each zone can deliver at least the minimum airflow for the system in both heating and cooling modes.
2. Oversize duct work by 25% to avoid excess noise at minimum zone airflow.
3. Be aware that heating airflow may be higher than cooling airflow depending on equipment combination.

## INSTALLATION AND START-UP OVERVIEW

This instruction covers installation of the Infinity Zone Control **only**. Physical installation instructions for the indoor and outdoor equipment, Damper Control Module, and accessories are provided with each unit.

Setup, commissioning, operation, and troubleshooting of the Infinity Zone System are covered in this installation instruction. It is the guide to connecting the system components and commissioning the system once all physical components are installed. Special screen prompts and start-up capabilities are provided in the Infinity System to simplify and automate the initial commissioning of the system.

- Install Infinity Zone Control according to this instruction.
- Install indoor unit, outdoor unit, and accessories according to their instructions.
- Wire complete system according to this instruction.
- Setup, commission, and operate system according to this instruction to assure a smooth and trouble free start-up.

## INSTALLATION

### Check Equipment and Job Site

Inspect equipment. File claim with shipping company prior to installation if shipment is damaged or incomplete.

## Infinity Zone Control Location and Wiring Considerations

### ⚠ WARNING

#### ELECTRICAL OPERATION HAZARD

Failure to follow this warning could result in personal injury or death.

Disconnect power before routing control wiring.

All wiring must comply with national, local, and state codes.

### Infinity Zone Control Location

The Infinity Zone Control User Interface is the command center for the Infinity Zone System and is typically located in Zone 1 to sense and control temperature in this zone. It should be located where it is easily accessible and visible to the adult homeowner or end user. For accurate temperature measurement, the following guidelines should be followed:

The Infinity Zone Control and Room Sensors should be mounted:

- Approximately 5 feet (1.5 meters) from the floor.
- Close to or in a frequently used room, preferably on an inside partitioning wall.
- On a section of wall without pipes or ductwork.

The Infinity Zone Control and Room Sensors should **NOT** be mounted:

- Close to a window, on an outside wall, or next to a door leading to the outside.
- Exposed to direct light or heat from a lamp, sun, fireplace, or other temperature-radiating objects which could cause a false reading.
- Close to or in direct airflow from supply registers.
- In areas with poor air circulation, such as behind a door or in an alcove.

### Remote Room Sensor Option

A Remote Room Sensor can be used with the Infinity Zone Control to take the place of the User Interface internal temperature sensor. This allows the Infinity Zone Control to be mounted in areas with less than optimal airflow (such as near an exterior door, window or in a closet). The remote sensor can be wired to the terminal block connectors labeled S1 and S2 at the User Interface backplate, or the OS1 and OS1C connection at the Damper Control Module. In either case, the Infinity Zone Control will automatically detect the Remote Room Sensor and ignore its internal temperature sensor. It is also important to note the humidity sensor cannot be remotely located, so do not locate the Infinity Zone Control in an area where humidity sensing may not be accurate.

**NOTE:** S1 & S2 connection on User Interface backplate is now used for Remote Room Sensor, NOT for OAT Sensor hookup.

In addition, the Remote Room Sensor is a temperature sensor only, having no additional user inputs. This sensor is typically connected to the Damper Control Module and used to sense and control temperature in each zone.

### Remote Sensor Averaging

Typically, one Remote Room Sensor is used per zone, but multiple sensors may be used and averaged in some applications. Averaging requires a special series-parallel wiring method with a specific number of sensors. See Fig. 2 in this manual for wiring diagram.

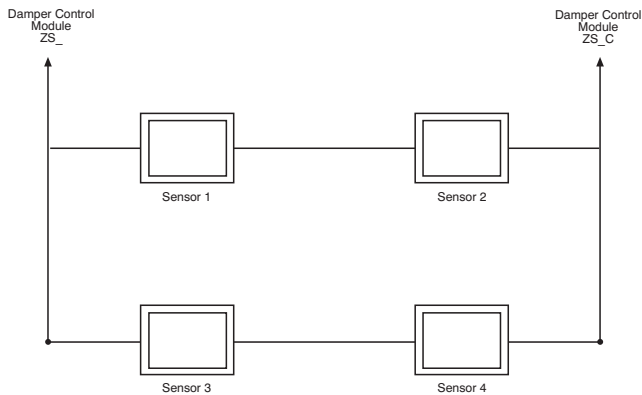

A03233

**Fig. 2 - Remote Room Sensor - Parallel Wiring**

### Smart Sensor

Any zone may use a Smart Sensor. It provides a temperature display and buttons to adjust the desired temperature in that zone only. It also displays outdoor temperature and indoor humidity sensed at the User Interface. Only one Smart Sensor may be used per zone. They cannot be averaged like Remote Room Sensors. If a Smart Sensor is used in a zone, a Remote Room Sensor may also be used in the same zone. The Remote Room Sensor has priority over the Smart Sensor. The Smart Sensor will display the Remote Room Sensor temperature.

**NOTE:** Smart Sensors must be addressed to identify which zone it will control. See Smart Sensor Installation Instructions for details.

### Wiring Considerations

Ordinary thermostat wire is recommended. Use 22 AWG or larger for normal wiring applications. Continuous wire lengths over 100 ft. should use 20 AWG or larger.

**NOTE:** ABCD bus wiring only requires a four-wire connection; however, it is good practice to run thermostat cable having more than four wires in the event of a damaged or broken wire during installation.

Each communicating device in the Infinity Zone System has a four-pin connector labeled ABCD. It is recommended that the following color code be used when wiring each device:

- A — Green = Data A
- B — Yellow = Data B
- C — White = 24VAC (Com)
- D — Red = 24VAC (Hot)

It is not mandatory that the above color code be used, but each ABCD connector in the system **MUST** be wired consistently.

### Locating Damper Control Module

All wiring is run back to the Damper Control Module. Select a location near the furnace or fan coil where wiring from the User Interface, each Remote Room Sensor or Smart Sensor, each damper actuator, and the equipment itself can come together easily.

The Damper Control Module is approved for indoor use only and should never be installed with any of its components exposed to the elements. The Damper Control Module (and zone dampers) may be installed in any area where the temperature remains between -4°F to 158°F (-20°C to 70°C), and there is no condensation. The cover must be installed to prevent damage from other sources. Do not locate where it will be accessible to children. It may be mounted in either vertical or horizontal position. Remember that wiring access is likely the most important consideration.

**⚠ CAUTION**

**ELECTRICAL OPERATION HAZARD**

Failure to follow this caution may result in equipment damage or improper operation.

To prevent possible damage to the Damper Control Module, **DO NOT** mount on plenum, ductwork, or flush against furnace or fan coil.

### Mounting Infinity Zone Control

There are two options for mounting the Infinity Zone Control to the wall. First, become familiar with all plastic assembly pieces shown in Fig. 3 through 10. The User Interface will snap together with either the Recess Mount or the Surface Mount backplate.

#### Recess Mount

This provides the thinnest mounting configuration (See Fig. 4). The backplate containing the recessed terminal block can be mounted directly to the wall by cutting a hole 1 1/2" (38.1 mm) wide by 2 1/8" (54 mm) high. Mark location and cut hole in wall.

**NOTE:** Always ensure the Infinity Zone Control location is acceptable before cutting any holes in wall.

#### Surface Mount

This provides surface mounting configuration, which allows use of a small hole in the wall. A surface mount backplate is supplied (See Fig. 5). Attach backplate as shown in Fig. 8, and the assembly will mount directly to the wall requiring only a small hole in the wall allowing a four wire connection to pass through.

**NOTE:** Once Infinity Zone Control is secured to wall with the backplate assembly (snapped together), care must be taken not to bend or break the interlocking tabs when removing. Gently remove Infinity Zone Control by rocking up/down until interlocking tabs release.

#### Decorative Backplate

Supplied is a thin decorative backplate (see Fig. 6) to hide any marks/screw holes left from the previous thermostat. This decorative backplate (or beauty ring) can be used in either the recess or surface mount installation by snapping it onto back of recessed mount backplate or surface mount backplate before securing to wall. See Fig. 9 and 10 for a larger decorative backplate P/N SYSTXXOLBP01 (5.75" / 146 mm wide x 6" / 152 mm high), which can be ordered separately.

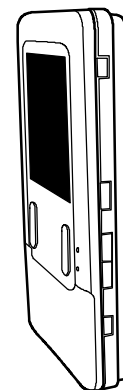

**Fig. 3 - Infinity™ Zone Control**

A03185

CCUIZ01--B

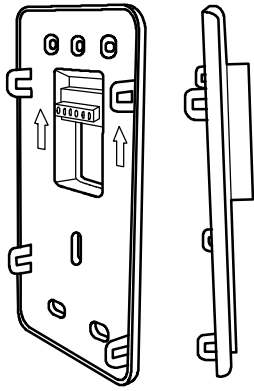

**Fig. 4 - Recessed Mount Backplate**

A03186

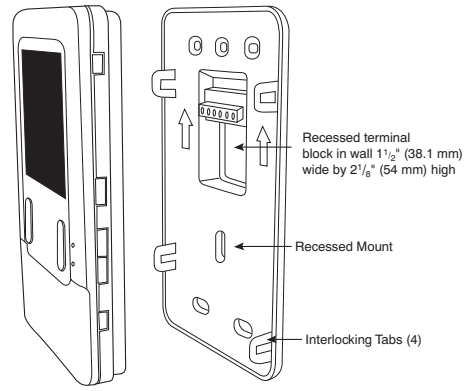

**Fig. 7 - Recessed Mount Assembly**

A07150

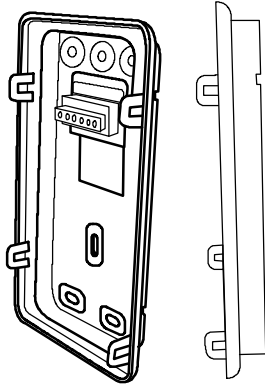

**Fig. 5 - Surface Mount Backplate**

A03187

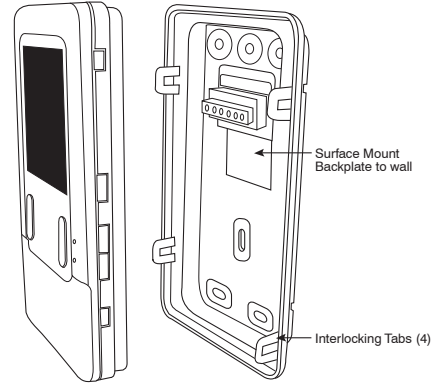

**Fig. 8 - Surface Mount Assembly**

A03191

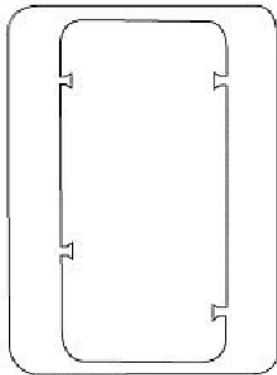

**Fig. 6 - Thin Decorative Backplate**

A04017

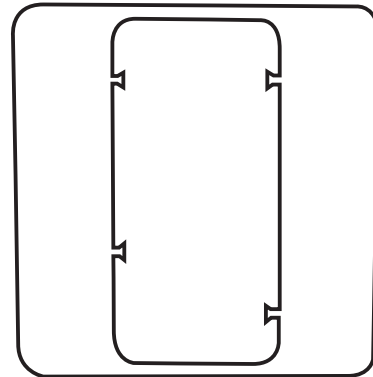

**Fig. 9 - Large Decorative Backplate**

A03188

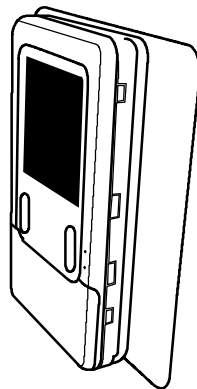

**Fig. 10 - Decorative Backplate Assembly**

A03192

CCUIZ01 --B

# INSTALLING INFINITY ZONE CONTROL

## ⚠ WARNING

### ELECTRICAL SHOCK HAZARD

Failure to follow this warning could result in personal injury or death.

Before installing Infinity Zone Control, turn off all power to equipment. There may be more than one power source to disconnect.

1. Turn off all power to equipment.
2. If an existing User Interface or control is being replaced:
  - a. Remove existing control from wall.
  - b. Disconnect wires from existing control.
  - c. Discard or recycle old control.

**NOTE:** Mercury is a hazardous waste, if existing control contains any mercury, it **MUST** be disposed of properly. The User Interface does not contain mercury.

3. Select Infinity Zone Control mounting plastic (recess mount or surface mount and decorative backplate if desired).
4. Route wires through large hole in mounting plastic. Level rear plastic against wall (for aesthetic value only - Infinity Zone Control need not be level to operate properly) and mark wall through two mounting holes.
5. Drill two 3/16" (4.8 mm) mounting holes in wall where marked.
6. Secure mounting plastic to wall using two screws and anchors provided.
7. Adjust length and routing of each wire to reach each wire entry on the connector backplate. Strip 1/4" (6.4 mm) of insulation from each wire.
8. Match and connect thermostat wires to proper terminals on User Interface backplate. See wiring diagram Fig. 11, 12, and 13.

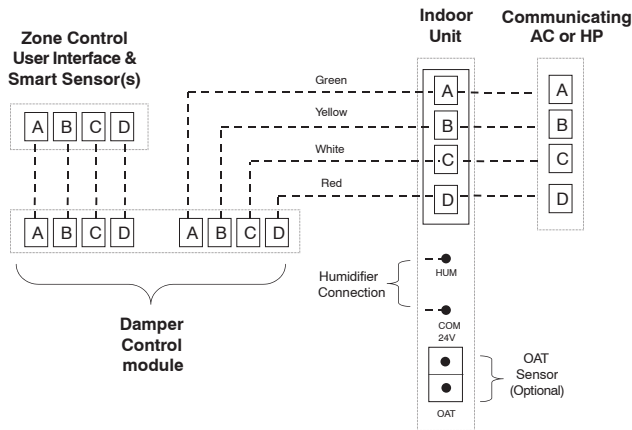

A04018

**Fig. 11 - Communicating Indoor Unit w/2-Stage Puron® Refrigerant Communicating Outdoor Unit**

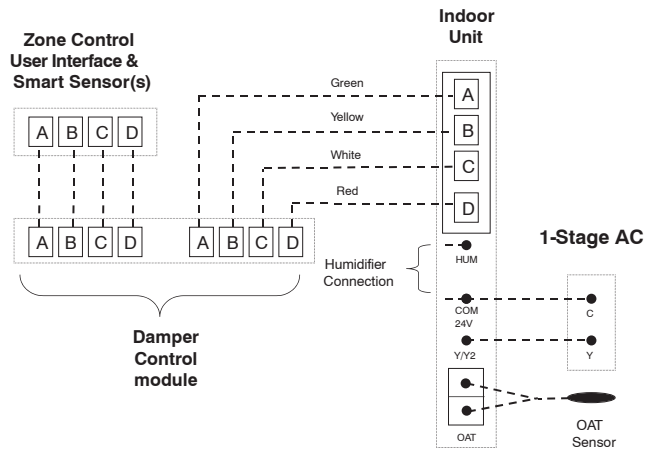

A04019

**Fig. 12 - Connection Diagram for Furnace or FE Fan Coil with Non-Communicating 1-Stage AC**

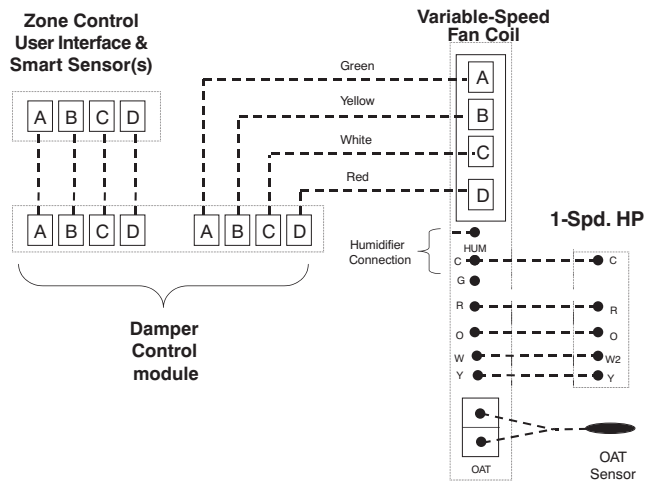

A07149

**Fig. 13 - Connection Diagram for FE Fan Coil with Non-Communicating 1-stage HP**

- A — Green = Data A
- B — Yellow = Data B
- C — White = 24VAC (Com)
- D — Red = 24VAC (Hot)

**NOTE:** It is not mandatory that the above color code be used, but each ABCD connection in the system **MUST** be wired consistently. A separate ABCD Connector comes inside packaging and should be used when connecting to furnace (or fan coil). Ensure connector is inserted properly into circuit board. (See Fig. 14.)

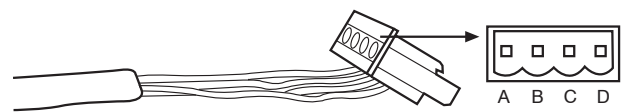

A03193

**Fig. 14 - Wire ABCD Connector**

CCUIZ01--B

## ⚠ CAUTION

### ELECTRICAL OPERATION HAZARD

Failure to follow this caution may result in equipment damage or improper operation.

Improper wiring of the ABCD connector will cause the Infinity Zone System to operate improperly. Check to make sure all wiring is correct before proceeding with installation or turning on power.

9. Push any excess wire into the wall. Seal hole in wall to prevent any air leaks. Leaks can affect operation.
10. Attach Infinity Zone Control to the mounting plastic by lining up the plastic guides on the back of the control with the opening on the mounting plastic and push on.
11. Perform installation of all other system equipment (i.e. dampers, humidifier, ventilator, UV lights, etc.)
12. Turn on power to equipment.

See wiring diagrams Fig. 11, 12, and 13 for connecting the Infinity Zone Control and Smart Sensors to the Damper Control Module. More information regarding Damper Control set-up and wiring can be found in Damper Control Module Installation Instructions.

See wiring diagram, Fig. 11, which includes an indoor communicating furnace or FE fan coil, with a 2-stage Puron® refrigerant communicating outdoor unit. No additional OAT (outdoor air temperature) sensor is required because the Infinity Zone Control will use the temperature sensor inside the outdoor unit.

See wiring diagram, Fig. 12, for connecting an indoor communicating furnace or FE fan coil with a 1-stage air conditioning unit (non-communicating outdoor). An Outdoor Air Temperature (OAT) sensor may be installed (but is not required) at the indoor furnace or fan coil OAT terminals. When OAT sensor is applied, the Infinity System will provide enhanced system features and benefits.

See wiring diagram Fig. 13 for connecting an FE fan coil with a 1-stage heat pump (non-communicating outdoor unit). When OAT is applied, the Infinity System will provide enhanced system features and benefits.

**NOTE:** For other applications not listed, refer to the Network Interface Module (NIM) Installation Instructions.

### Humidifier Connection

A 24VAC bypass or fan powered humidifier may be installed.

**NOTE: Do Not Use** a traditional humidistat to control humidifier operation. If a humidifier is installed, let the Infinity Zone Control operate humidifier.

### Bypass Humidifiers

A bypass humidifier should be wired directly to the furnace or fan coil HUM and 24VAC COM terminals. The Infinity Zone Control will automatically energize the HUM output during a call for humidification.

### Fan Powered Humidifiers

Most fan powered humidifiers produce internal 24VAC in order to energize upon a switch or contact closure. For this application, a 24VAC N.O. Isolation Relay (DPST) **MUST** be used to prevent mixing the internal humidifier power with the indoor equipment transformer. Applying 24VAC isolation relay coil to furnace or fan coil HUM and COM terminals will allow the Infinity Zone Control to automatically energize the HUM output during a call for humidification. The N.O. relay contacts will be used to energize the humidifier. See fan powered humidifier installation instructions for more details.

CCUIZ01 --B

## ⚠ CAUTION

### EQUIPMENT HAZARD

Failure to follow this caution may result in equipment damage.

Do not apply 24VAC fan powered humidifier (with internal power supply) direct to indoor unit HUM and COM terminals.

## INITIAL POWER-UP

**NOTE:** Refer to Functional Overview (Fig. 15) to become familiar with key function buttons such as “System On/Off”, “Zone”, “Fan”, “Left-Side” and “Right-Side” buttons, etc. These function buttons will be used frequently during setup.

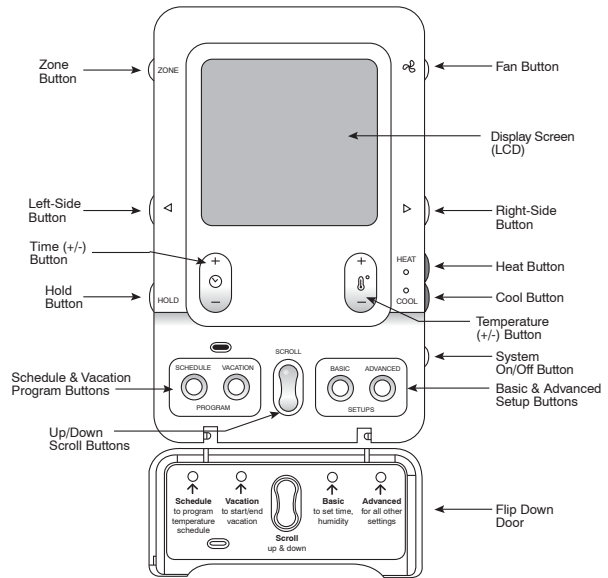

A04038

Fig. 15 - Functional Overview

## Power Up Sequence

This section addresses initial power up (or commissioning) of a new Infinity Zone Control. The User Interface will communicate and identify all Infinity components in the system. The following is a typical example for a communicating Variable-Speed Furnace / Fan Coil with a 2-stage Air Conditioner / Heat Pump (including Hybrid Heat).

The User Interface display will light up and indicate that it is now “ESTABLISHING COMMUNICATIONS WITH EQUIPMENT PLEASE WAIT”. The User Interface will automatically continue by “SEARCHING FOR EQUIPMENT”, followed by “SEARCHING FOR OUTDOOR EQUIPMENT” (See Fig. 16). Once the indoor and outdoor equipment has been found, the Installer will be asked to select Accessories. Packaged Products will be automatically identified and the Installer will be asked to select Accessories. Proceed to Selecting Accessories.

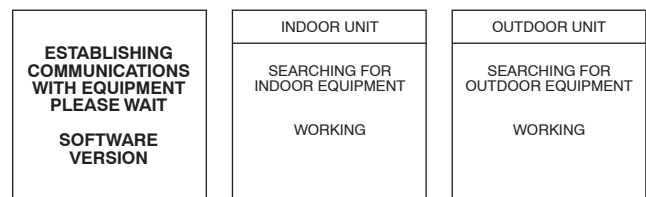

A03195

Fig. 16 - Power Up Sequence

**NOTE:** If the variable-speed indoor equipment (furnace or fan coil) cannot be found, the User Interface will display “CANNOT COMMUNICATE WITH INDOOR UNIT”. This **MUST** be corrected before the initial power up sequence can continue. If indoor unit is found, but outdoor unit is not found, “OUTDOOR UNIT NOT IDENTIFIED” will appear. Proceed to the next section for Outdoor Unit Identification.

### Selecting Outdoor Unit

If there is no communicating outdoor unit, the screen, shown in Fig. 17, will appear. Press either Time or Temp +/- buttons to select AC (air conditioner), HP (heat pump), or None (no unit installed). Press right-side button to continue to next screen.

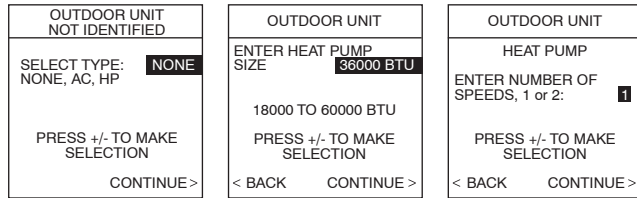

A03196

**Fig. 17 - Selecting Outdoor Unit**

If either AC or HP has been selected as the outdoor unit type, the middle screen will appear (See Fig. 17). Press either Time or Temp +/- buttons to select appropriate Btu size of outdoor unit, then press right side button to continue. If a NIM (Network Interface Module) is applied for non-communicating two-stage outdoor equipment, select 1 or 2-stage compressor operation, and press right-side button to continue.

**NOTE:** Range of outdoor unit Btu selection is limited by model number of indoor unit installed. The Infinity Zone Control will not allow an outdoor unit size that is not supported by the installed indoor unit.

**NOTE:** On new system installations, the model and serial number will be recognized and displayed. On any indoor/outdoor board replacements, the equipment will be recognized but the exact model/serial number will not be displayed.

### Selecting Electric Heater

If the equipment is a fan coil, packaged heat pump, or packaged AC and the electric heater is not self-identifying, “ELECTRIC HEATER NOT IDENTIFIED” will appear (See Fig. 18). Press either Time or Temp +/- buttons to select appropriate size of electric heater installed, then press right-side button to continue. An asterisks (\*) will appear next to electric heater sizes that may cause excessive airflow.

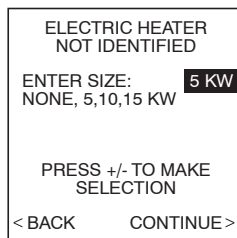

A03197

**Fig. 18 - Selecting Electric Heater**

**NOTE:** Range of electric heaters available is limited by model number of the equipment installed. The Infinity Zone Control will not allow an electric heater size that is not supported by the installed equipment.

## Hydronic Heat Applications

The -B model of the Infinity Zone Control supports Hydronic Heat applications in the form of a hot water coil on FE fan coils only. If an FE fan coil is installed, a Hydronic Heat kit should be installed in place of the electric heater. See FE fan coil Product Data for accessory part number. The system will identify that hydronic heat has been installed during the initial commissioning process. The system will treat the hot water coil as either auxiliary heat in a heat pump application, or the sole heat source. Setup options for Hydronic Heat applications are described in the Setup section of this instruction.

### Selecting Accessories

Once the indoor and outdoor equipment have been found or entered, the following screens will appear allowing the Installer to select the “AIR FILTER TYPE; HUMIDIFIER INSTALLED”; and “UV LIGHTS INSTALLED” (See Fig. 19). Use either Time or Temp +/- buttons to make appropriate selections in the highlighted area on the display screen. Press right-side button to continue (or advance) to the next screen.

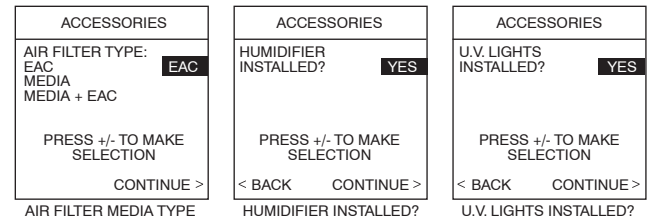

A03198

**Fig. 19 - Accessories —UV Lights**

#### Air Filter Type

This accessory screen will appear first. The installer will need to enter the type of filter (MEDIA, EAC, or both). See Table 1 and make a selection using Time or Temp +/- button, then press right-side button to continue.

**Table 1 – Filter Selection**

INSTALLED FILTER	MENU SELECTION
1 inch to 4 inch media	MEDIA
High voltage EAC	EAC
High voltage EAC + 1 to 4 inch media	MEDIA + EAC
Infinity™ Air Purifier	MEDIA

#### Humidifier Installed

This will appear after the Air Filter Type screen. Select whether a humidifier is installed on the system, YES or NO, then press right-side button to continue.

#### UV Lights Installed

This screen will appear to select whether UV lights are installed on the system, select YES or NO, then press right-side button to continue.

#### Zoning

“SEARCHING FOR ZONE EQUIPMENT” will appear on the screen to identify the number of zones detected. This screen will show Zone 1, Zone 2, etc. and indicate all zones having either a Remote Room Sensor, or smart sensors associated with them. If the system contains smart sensors, they must be assigned a zone number before continuing. See Smart Sensor Installation Instructions on how to assign Smart Sensors to their respective

zones. When finished, press right-side button to continue. See Fig. 20.

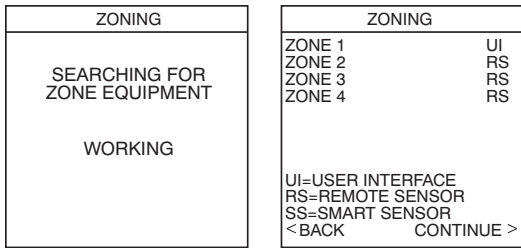

Fig. 20 - Zoning

A04084

## Equipment Summary

The “EQUIPMENT SUMMARY” screen will appear after Accessories have been selected. This screen will give a summary of all equipment automatically found or manually selected. If a wrong selection was made, press left-side button (BACK selection) to go back to that particular screen and make changes. When everything is OK, press right-side button again to continue. (See Fig. 21.)

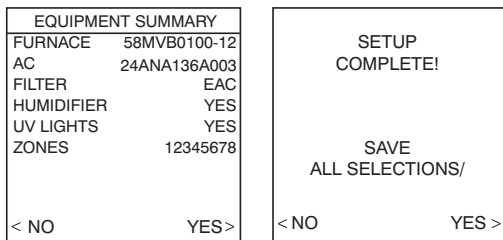

Fig. 21 - Equipment Summary

A07024

The “SETUP COMPLETE! SAVE ALL SELECTIONS?” screen will appear after Equipment Summary. To Save All Selections press (YES) right-side button. Pressing the left-side button (NO selection) will return to the Equipment Summary screen where changes can be performed to any of the equipment selection screens. After selecting YES, the initial power up sequence of the new Infinity Zone Control is complete.

## Static Pressure Check

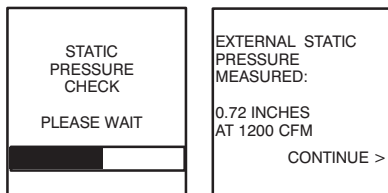

Fig. 22 - Static Pressure Check

A05000

This screen will appear after Setup is exited. The system will open all dampers and perform a static pressure check. This process will take about 1 1/2 minutes to complete. When completed, a screen will appear displaying the static pressure (in inches) across the equipment at the expected highest delivered airflow. If the static pressure is over 1 inch, a warning will appear, but equipment operation and the TrueSense™ dirty filter detection operation will not be affected.

**NOTE:** The static pressure check occurs only at initial installation, or when INSTALL is run in the INSTALL/SERVICE menu.

## Duct Assessment

The following screen will appear after STATIC PRESSURE screen is exited. Press right-side button to start Duct Assessment. Duct

Assessment will measure the relative size of the ductwork, up and through the dampers. These measurements are used to control the correct amount of airflow in the zoned system. Status messages will appear on the screen to indicate what the system is doing. The process will take approximately one minute per zone. The duct assessment will override a call for heat or cool.

A duct assessment will automatically occur each day at a user selectable time. The factory default time is 1:00 p.m. but, may be changed by entering the Zoning Setup menu. See Zoning Setup section of this manual. The duct assessment will override a call for heat or cool. The system will first open all zones and drive the blower to 175 CFM/ton of cooling (or the minimum indoor unit’s airflow, whichever is greater). It will then take a static pressure measurement. The system will then close all zones and open one zone at a time, taking a static pressure measurement for each zone. The system will then close all zones and take a pressure measurement, getting a value for the duct leakage up to and through the dampers. With these static pressure measurements, the system will calculate the relative size of each zone as well as the percent leakage through the dampers. At the end of the process, the display will show the relative size of each zone duct. See Fig. 23.

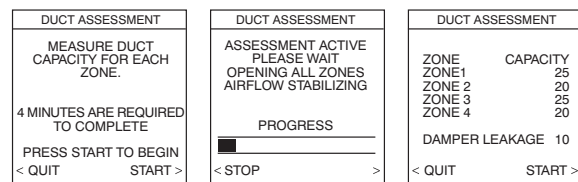

Fig. 23 - Duct Assessment

A04085

## QUICK START

For first time installers, Quick Start will allow a quick start up of the Infinity Zone System before learning all the details of system operation. However, for the best possible comfort and operation refer to the Infinity Zone Control Owner’s Manual.

### Set Day, Time & Desired Humidity

1. Flip down the door at the base of the Infinity Zone Control and press the **BASIC** button.
2. Adjust the highlighted **HOUR** setting using the **TIME (+/-)** button.
3. Press **SCROLL** button (down) to highlight **MINUTE**.
4. Adjust the **MINUTE** setting using the **TIME (+/-)** button.
5. Press **SCROLL** button (down) to highlight **DAY**.
6. Adjust the current **DAY** setting using the **TIME (+/-)** button.
7. Press **SCROLL** button (down) to highlight **HUMIDITY**.
8. Press the red **HEAT** button to select heating humidity.
9. Adjust desired heating humidity level using either (+/-) button.
10. Press the blue **COOL** button to select cooling humidity.
11. Adjust the desired cooling humidity level using either (+/-) button.
12. To exit press **BASIC** button or close door.
13. If changes are made, you will be asked to “**SAVE CHANGES? YES/NO.**”

### Override Heating Schedule

1. Press the red **HEAT** button. Heating mode is confirmed when the red LED next to the red **HEAT** button is lit.
2. Use the **TEMP (+/-)** button to select your desired heating temperature.
3. The default time for temporarily overriding the temperature schedule is 2:00 HRS as indicated by the text on the lower left.

**NOTE:** Override time will not appear if programming has been turned off.

- You can change the temporary override time in 15-minute increments by pressing the **TIME (+/-)** button until the desired override time is selected, or press the **HOLD** button anytime to override the schedule indefinitely.

### Quick Program Schedule For All Days

This section will give you a quick program schedule for **ALL DAYS** of the week. For more information on how to create customized schedules for every day, the entire week, or weekend, refer to the Owner's Manual.

- Flip down the door at the bottom of the control.
- Press the **SCHEDULE** button, which allows you to create one schedule for the entire home.
- Press either the **LEFT** or **RIGHT** side button repeatedly (if necessary) until "ALLDAYS" is displayed. The **WAKE** time period will be highlighted.
- Using the **TIME (+/-)** button, set the start time for this time period.
- Press the red **HEAT** button. Heating temperature will begin flashing.
- Set the heating temperature using the **TEMP (+/-)** button.
- Press the blue **COOL** button. Cooling temperature will begin flashing.
- Set the cooling temperature using the **TEMP (+/-)** button.
- Set the remaining periods by using the **SCROLL** button to select "DAY", "EVENING", and "SLEEP".
- To copy a zone, use **SCROLL** button to select "COPY". Select **YES** and copy this zone schedule to other zones using **NO** or **YES**.
- Exit the scheduling mode by either closing the door or pressing the **SCHEDULE** button.
- If changes are made, you will be asked to "SAVE CHANGES YES/NO."

### INSTALL / SERVICE MENUS

The "INSTALL / SERVICE" menus contain a set of vital information. This information enables the Installer or Service person to view a summary of what has been installed, etc. This information is not covered in the Owner's Manual.

To enter **INSTALL / SERVICE** menus, press and hold the **ADVANCED** button for at least ten seconds. The following menu will appear (See Fig. 24):

INSTALL/SERVICE	
EQUIPMENT SUMMARY	
INSTALL	
SETUP	
CHECKOUT	
SERVICE	
SOFTWARE VERSION 1	
<EXIT	SELECT>

A03200

**Fig. 24 - Install / Service Menus**

**NOTE:** The **INSTALL / SERVICE** menu will automatically exit after 60 minutes of no push button activity.

**EQUIPMENT SUMMARY:** Shows all equipment recognized by and attached to the system.

**INSTALL:** Used when adding, changing out, or un-installing equipment.

**SETUP:** Used to view or modify equipment settings.

**CHECKOUT:** Allows testing of equipment operation

**SERVICE:** Used to view operation and fault history of equipment and enter dealer name/phone number for display

### EQUIPMENT SUMMARY MENU

EQUIPMENT SUMMARY	
FURNACE	58MVB0100-12
AC	24ANA136A003
FILTER	EAC
HUMIDIFIER	YES
UV LIGHTS	YES
ZONES	1234
< BACK	

A07117

**Fig. 25 - Equipment Summary**

This screen shows indoor unit type and model number, outdoor unit type (and model number if a 2-stage unit), filter type and any accessories that are installed, and how many zones are recognized.

### INSTALL MENU

INSTALL	
TO ADD, UNINSTALL OR RE-INSTALL EQUIPMENT, PRESS RIGHT SIDE BUTTON	
< BACK	INSTALL >

A03202

**Fig. 26 - Install Menu**

This menu item will perform start-up process in order to learn all equipment in system. Press right side button to initiate the process. See Fig. 26.

### SETUP MENU

SETUP	
THERMOSTAT	
FURNACE	
HEAT PUMP	
ZONING	
ACCESSORIES	
SYSTEM MAINTENANCE	
< BACK	SELECT >

A04089

**Fig. 27 - Setup Menu**

This menu has several layers, allowing modification of equipment settings. No settings will need to be made at equipment (i.e. DIP switches on a furnace). All configuration settings made effective from this menu will override equipment configuration made by dip switches. Fig. 27 shows all the information that can be found in the **SETUP** menu.

### Setup - Thermostat

#### Auto Mode Setup:

- Enable/Disable Auto Changeover mode (default=Enable).
- Auto Changeover Time may be adjusted 5 to 120 minutes, (default = 30 minutes).

When Auto mode is enabled (factory default) a change from heat to cool (or vice versa) will not occur until an opposite mode demand has existed for 30 minutes. If the setpoint is changed, the 30 minute timer is deleted.

#### Heat/Cool Deadband:

- 0 to 6°F / 0 to 3°C, (default = 2°F).

The minimum difference enforced between heating and cooling desired temperatures. This can allow one setting to "push" the other to maintain this difference.

**Offsets:**

This option allows calibration (or deliberate miscalibration) of the temperature and humidity sensors. These offsets are added to the actual temperature/humidity values (defaults=0).

- Zone 1 Offset: -5 to +5°F (-3°C to +3°C).
- Outside Temp Offset: -5 to +5°F (-3°C to +3°C).
- Humidity Offset: -10 to +10%.

**Cycles Per Hour:**

- Maximum cycles per hour = 4 (default) or 6.
- Anticipator = 1 to 9 (default=3). This adjusts sensitivity to temperature changes. 1 = most sensitive, 9 = least sensitive.
- If space is over-conditioning, increase the anticipator setting.
- If space is under-conditioning, decrease the anticipator setting.

**Programming:**

- ON (default)- allows program schedule to be set by user.
- OFF - system becomes non-programmable
- Periods Per Day = 2 or 4 (default=4)
- Programmable Fan On/Off (default=Off). If ON is selected, fan can be set to Auto, Low, Med, or High.

**Smart Recovery:**

- On or Off (default=On)

Applies to programmable operation only. Will start recovery 90 minutes prior to schedule change in both heating and cooling mode. Refer to operational information for more detail.

**English/Metric Display:**

- °F or °C (default = °F)

**Reset Factory Defaults:****Program Schedule:**

- Yes/No to reset back to Energy Star default Time and Temp schedules.

**User Settings:**

- Yes/No to reset the user settings in the Advanced Setup to factory default settings.

**Install Settings:**

- Yes/No to reset install settings in Install/Service menus to factory default settings.

**Last 10 System Events:**

- Yes/No to reset last 10 system events under Service Info menu.

**Setup - Furnace**

Upon a first time start-up of the Infinity Zone Control, the furnace DIP switch settings will be copied to the furnace setup menu. Any changes can then be made from the Infinity Zone Control.

**Airflow:**

- COMFORT (default)
- EFFICIENCY

Selects the airflow of the furnace when heating. **EFFICIENCY** is the airflow used to meet specified ratings, **COMFORT** is a decreased airflow used to increase the output air temperature and provide increased comfort.

**AC Airflow:**

- COMFORT (default) - cooling airflow is varied depending on humidity and temperature demands settings. This selection enables the full dehumidify and comfort capabilities of the system. When COMFORT is not selected, the unit will not run reduced airflows for dehumidification.

- **EFFICIENCY** - fixed airflow used to achieve specified ratings - no dehumidification airflow reduction. This is nominally 350 CFM/ton, but will vary if a 2-stage outdoor unit is used.
- **MAXIMUM** - 400 CFM/ton.

**Dehum Airflow:**

- **NORMAL** (factory default) - When equipment is running to dehumidify, the airflow is allowed to adjust to a minimum to satisfy the dehumidification call.
- **HIGH** - Minimum airflow during the dehumidify mode is increased to reduce duct and register sweating. Also increases minimum airflow during normal cooling operation to reduce duct sweating.

**Low Heat Rise**

- ON
- OFF (default)

Set to **ON** if the system contains a bypass humidifier. The **ON** setting will increase the furnace low heat airflow.

**Staging**

- SYSTEM (default)
- LOW
- HIGH

Controls the staging of the furnace. **SYSTEM** setting will allow the Infinity Zone Control to determine furnace staging. **LOW** will only run the low stage of furnace heat. **HIGH** will only run the high stage of furnace heat.

**G Terminal**

This setup option selects desired operation when the R-G circuit changes state on the furnace control board depending on setup.

- **DISABLED** (Default)
- **FAN** - turns on fan to selected fan speed when G terminal is energized. See Fig. 28.

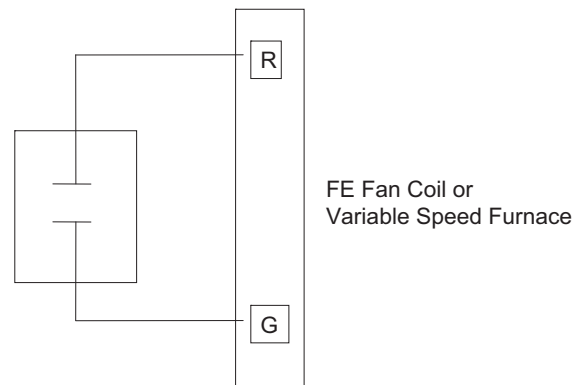

A07114

**Fig. 28 - G Input Wiring for Blower Operation**

- **FAN SPEED** - select Low, Med, High for all zones when G terminal is energized
- **SHUTDOWN** - shuts off fan and equipment when initiated. This function is not intended for emergency fire shutdown. It may be activated by a dry contact from an external device such as a float switch or a relay. User selects whether the contact is NC - normally closed (default) or NO - normally open. User Interface displays SYSTEM MALFUNCTION on screen and registers G terminal shutdown event in Last 10 System Events. See Fig. 29.

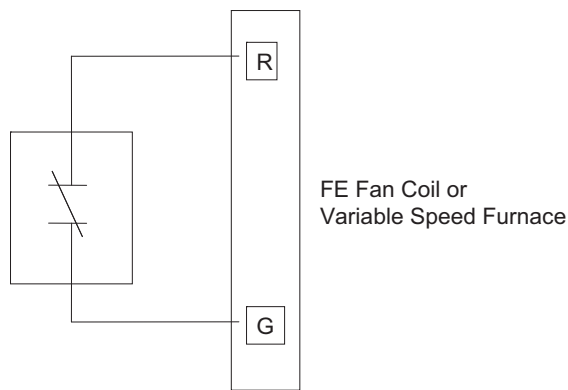

A07115

**Fig. 29 - G Input Wiring for System Shutdown with (-B) Infinity™ Control (Contact type selectable; Normally Closed (default) or Normally Open)**

### High Stage Timer

Minimum amount of time low stage must operate before high stage is activated. Ten to 60 minutes. 10 = default

A demand of 5° or more will override the staging timer.

### Off Delay

- 90 seconds
- 120 seconds (default)
- 150 seconds
- 180 seconds

Amount of time the blower will continue to run after heating has shut off.

### Setup - Fan Coil

#### HP/AC Airflow:

- **COMFORT** (default) Cooling airflow is varied depending on humidity and temperature demand settings. This selection enables the full dehumidify and comfort capabilities of the system. When **COMFORT** is not selected, the unit will not run reduced airflows for dehumidification. Heat Pump airflow is varied depending on outdoor temperature to maximize comfort.
- **EFFICIENCY** - fixed airflow used to achieve specified ratings - no dehumidification airflow reduction. This is nominally 350 CFM/ton, but will vary if a 2-stage outdoor unit is used.
- **MAXIMUM** - 400 CFM/ton. Dehumidify features are not active when set to maximum.

#### Dehum Airflow:

- **NORMAL** (factory default) - When equipment is running to dehumidify, the airflow is allowed to adjust to a minimum to satisfy the dehumidification call.
- **HIGH** - Minimum airflow during the dehumidify mode is increased to reduce duct and register sweating. Also increases minimum airflow during normal cooling operation to reduce duct sweating.

#### Heater Size:

- (choices dependent upon fan coil model)

This will show the heater size entered during the start-up process. This value can be changed to another value (limited by the model number of the fan coil). If the electric heater is self-identifying, this value is not shown.

#### Elect Heat Lockout

- NONE (default)
- +5 to 55°F / -15 to 18°C

Outside temperature above which the electric heat will not operate except for defrost.

#### G Terminal

This setup option selects desired operation when the R-G circuit is made on the fan coil control board.

- **DISABLED** (Default)
- **FAN** - turns on fan to selected fan speed when G terminal is energized. See Fig. 28.
- **FAN SPEED** - select Low, Med, High for all zones when G terminal is energized.
- **SHUTDOWN** - shuts off fan and equipment when initiated. This function is not intended for emergency fire shutdown. It may be activated by a dry contact from an external device such as a float switch or a relay. User selects whether the contact is NC - normally closed (default) or NO- normally open. User Interface displays SYSTEM MALFUNCTION on screen and registers G terminal shutdown event in Last 10 System Events. See Fig. 29.

### Setup - Heat Pump / AC

#### Cooling Lockout:

- NONE (default)
- 45°F / 7°C
- 50°F / 10°C
- 55°F / 13°C

Outside temperature below which cooling will not be provided.

#### Low Ambient Cooling:

- NO (default)
- YES

Selecting **YES** will enable the low ambient cooling operation in the outdoor unit. This setting is only available with communicating outdoor units and with Cooling Lockout set to **NONE**.

For detailed sequence of operation, see outdoor unit installation instruction.

#### Entered Size:

- (dependent on indoor unit model)

Size of the outdoor unit entered during the start-up process. If the outdoor unit is a communicating model, this value will not be shown. This size can be changed here but is limited to sizes that the indoor unit can handle.

#### Defrost Interval:

- 30 minutes
- 60 minutes
- 90 minutes
- 120 minutes (default)
- Auto-Defrost interval optimized by outdoor control (default for communicating HP)

Time interval at which defrost cycles can occur on a heat pump.

#### High Cool Latch:

- NONE (default)
- On
- 80 to 110°F / 27 to 43°C

Outside temperature above which only the high speed (of a 2-stage outdoor unit) will run when cooling.

#### High Heat Latch

- OFF (default)
- On
- 20 to 50°F / -7 to 10°C 2 -stage heat pump runs only high stage heating below a selectable outdoor temperature. Selections

from 20 to 50°F / -7 to 10°C are available in 5° increments.

## Setup - Hybrid Heat

HYBRID HEAT SETUP	
OUTSIDE LOCKOUT TEMPS	
FURNACE LOCKOUT:	> 30 F
HEAT PUMP LOCKOUT:	< 15 F
DEFROST W/FURNACE:	YES
HP TO FURNACE STAGE TIME:	15 MIN
< BACK	

Fig. 30 - Hybrid Heat Setup

A07030

**FURNACE LOCKOUT** - Temperature above which the furnace will not operate, except for defrost.

- Default = NONE
- Available settings = NONE thru >55°F / 13°C

**HEAT PUMP LOCKOUT** - Temperature below which the heat pump will not operate.

- Default = NONE
- Available settings = NONE thru <55°F / 13°C

**DEFROST W/FURNACE** - Choose whether furnace operates during defrost cycle

- Default = YES
- Available settings = YES / NO

**HP TO FURNACE STAGING TIME** - Adjust the minimum amount of time high stage heat pump will run before furnace will be allowed to run.

- Default = 15 MIN
- Available settings = 15-60 minutes

## Setup - Zoning

### Disable Zoning:

- NO (default)
- YES

If YES is selected, zoning is disabled and all dampers open. The system will run un-zoned using the Zone 1 sensor.

### Zone Offsets:

- Zone Temperature Offsets (default = 0) Range -5°F to +5°F / -3°C to +3°C

This option allows actual temperature offset for each zone, allowing calibration (or deliberate miscalibration) of each sensor.

Humidifier interval is time only, not actual humidifier run time.

### Airflow Limits:

Since bypass damper is prohibited in this system, this setting is used to select the maximum allowable noise/airflow relationship into each zone based on air noise and comfort requirements. For setup guidelines, see Airflow Limits Checkout in the next section.

- Low - 100% of maximum assessed airflow
- Medium - 150% of maximum assessed airflow
- High (default) - 200% of maximum assessed airflow
- Maximum - no limit

Assessed airflow is determined as described in DUCT ASSESSMENT.

### Duct Assessment Time

1 p.m. (default), adjustable in 1 hour increments from 1 p.m. to 12 AM (24 hours). Select which hour of the day the duct assessment will be performed.

## Setup - Hydronic Heat

HYDRONIC HEAT SETUP	
HOT WATER LOCKOUT:	
HEAT PUMP LOCKOUT:	> 30 F
DEFROST W/WATER:	YES
AIRFLOW:	800 CFM
BLOWER ON DELAY:	30 SEC
BLOWER OFF DELAY:	30 SEC
< BACK	

A07031

Fig. 31 - Hydronic Heat Setup

**HOT WATER LOCKOUT** - Outside temperature above which the hot water will not operate except for defrost (if selected).

- Available settings - NO, 5 to 55°F / -15 to 13°C in 1° increments

**HEAT PUMP LOCKOUT** - Outside temperature below which the heat pump will not operate, 1° resolution.

- Appears only with a heat pump outdoor unit.
- Available settings - NO, 5 to 55°F / -15 to 13°C in 1° increments

**DEFROST W/WATER:**

- Available settings: YES / NO (Default = YES)
- Appears only if heat pump is available. If no, hot water will not run during a defrost.

**AIRFLOW** - Selects desired airflow during Hydronic Heating

- Available range from OFF, 500 CFM (minimum) to 400 CFM/ton cooling maximum in 50 CFM increments.
- Default is the cooling airflow. (350 CFM/ton)
- OFF selection does not turn off airflow if heat pump is defrosting.

**BLOWER ON DELAY** - Time after hot water is requested that the blower will turn on.

- Available settings - 0 to 240 seconds in 30 second increments
- Default is 30
- Does not appear if a heat pump is present since heat pump and hot water run simultaneously.

**BLOWER OFF DELAY** - Time after hot water request terminates before the blower will turn off.

- Available settings - 0 to 240 seconds in 30 second increments
- Default is 0

## Setup - Accessories

### Filter Type:

- MEDIA (i.e. TrueSense™)
- EAC
- MEDIA+EAC (i.e. TrueSense™)

**CLEAN INTERVAL:** 30 to 180 days (of actual blower operation). (Default = 90)

Interval at which the Clean Filter notification will turn on. Applies to EAC filter selection only.

### Humidifier Installed:

- NO
- YES

If YES, indicates to the system whether a humidifier is installed and enables humidification functions.

**CHANGE PAD INTERVAL:** 1 to 24 months (default=12 months)  
Interval at which the Change Humidify Pad notification will be displayed.

HUMIDIFY WITH FAN (Heating Mode Only):

- NO (default)
- YES

If YES, the humidifier will turn on if there is a humidify demand present. The fan will turn on to Low speed if the fan setting is Auto.

**Ventilator:**

**NOTE:** Only appears if ventilator is installed.

**CLEAN INTERVAL:**

- 60 to 180 days of actual operation (default=90)

Interval at which the Clean Ventilator Pre-filter notification will turn on.

**UV Lights Installed**

- NO
- YES

If YES, indicates to the system whether UV lights are installed.

**CHANGE INTERVAL:**

- 6 to 48 months operation time (default=12 months)

Interval at which the Change UV Lights notification will be displayed.

**Setup - System Maintenance**

**Remind Owner of Routine Maintenance Every:**

This setup is used to adjust the timer interval in which the normal System Maintenance notification is turned on for the homeowner.

Range =

- OFF
- 6 to 24 months, (default=12 months) Pressing the right side button will reset the timer. Pop-up confirmation will be shown.

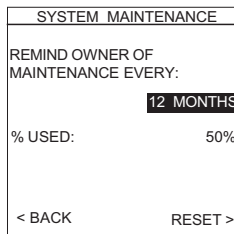

Fig. 32 - System Maintenance

A07033

**Setup - Utility Saver**

**Cooling/Heat Pump Heating (Hybrid Heat &Hydronic Heat only):**

- Turn off, Low Stage

Utility Saver is used to force the equipment to a lower stage (low or off) when activated by the utility company, typically during peak load times.

This setup is available only if the equipment has a utility saver input (refer to equipment Installation Instructions.) This setup controls the response of the equipment when the utility saver input is active.

The choices include:

- Turn Off , (equipment turns off)
- Low Stage (available if the AC/heat pump is a 2-stage model, runs low speed only)

**CHECKOUT MENUS**

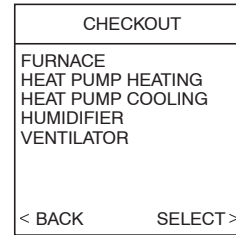

Fig. 33 - Checkout Menu

A03204

The Checkout menu will show the equipment installed in the system. A sample checkout menu is shown in Fig. 33.

**Checkout - Furnace or Gas PAC**

Make sure the furnace is properly installed before continuing.

- LOW HEAT RUNTIME: 5 min.
- HIGH HEAT RUNTIME: 5 min.

This menu item allows the furnace to be exercised. First, a low heat runtime and high heat runtime are selected. Range = 5 - 120 min.

If only the low heat is to be exercised:

The furnace will execute its ignition start-up sequence. This sequence will be displayed on the Infinity Zone Control screen. After the gas valve and blower motor turn on, the screen will automatically change to "FURNACE CHECK" and show the current operating status of the furnace.

**Checkout - Electric Heat**

- ELECTRIC HEAT RUNTIME: 5 min., Default time = 5 min., Range = 0 - 120 min.

If you have a fan coil with electric heaters, this menu item will allow the heaters to be exercised.

With self-identifying electric heaters, three stages of electric heat are available to be exercised in any combination. Non-identifying heaters will only provide one stage of heat.

Enter the run time (in minutes) of each stage of heat to be exercised then press START (right-side button). The display will change to show the fan coil's operating status.

**Checkout - Heat Pump Heating**

- HIGH HEAT RUNTIME: 5 min.
- LOW HEAT RUNTIME: 5 min.
- DEFROST: NO

The heat pump heating mode can be exercised with this menu option. With a 2-stage heat pump, a low heat runtime and a high heat runtime are independently selectable to exercise. A defrost cycle is also selectable. Default time = Fixed 5 min. minimum, range = 5 - 120 min.

**NOTE:** Airflows during Checkout modes are fixed to the Efficiency setting and are independent of other airflow settings. To view airflows for normal heat pump heating mode, exit the Checkout screen and apply a heating demand to the system.

**Checkout - Heat Pump Cooling or AC Cooling**

- HIGH COOL RUNTIME: 5 min.
- LOW COOL RUNTIME: 5 min.

The heat pump cooling mode (or AC cooling mode) can be exercised with this menu option. With a 2-stage heat pump or AC unit, a low cool runtime and a high cool runtime are independently selectable to exercise. The display will change to show the heat pump or AC operating status.

Default time = Fixed 5 min. minimum, range = 5 - 120 min.

CCUIZ01--B

**NOTE:** Airflows during Checkout modes are fixed to the Efficiency setting and are independent of other airflow settings. To view airflows for normal heat pump heating mode, exit the Checkout screen and apply a heating demand to the system.

### Checkout - Humidifier

- OFF
- ON

The humidifier can be exercised On and Off with this menu option.

### Checkout - Ventilator

#### Speed:

- OFF
- LOW
- HIGH

The ventilator can be exercised through all of its operating speeds with this menu option.

### Checkout - Zoning

#### Duct Assessment

This is the same Duct Assessment that runs on first start-up. Measures duct capacity for each zone. The Duct Assessment will perform an airflow measurement on each zone and determine the relative size of each zone along with damper leakage. This assessment will require approximately 1 minute for each zone in the system.

**NOTE:** A Duct Assessment will automatically occur every 24 hours at selected time to check system static and calibrate dampers.

#### Sensor / Damper Check:

The Sensor/Damper Check allows the installer to check each zone damper for operation, as well as insure the zone sensor corresponds to that particular zone.

When first initiated, the Zone 1 damper will fully open, and all other zones will close. Using the scroll button, the installer can select each zone and verify the damper is fully open while all other dampers remain closed.

After proper damper operation has been verified, the installer can now check and verify that each Remote Room Sensor corresponds to the proper zone damper in the same zone. Start from the top and highlight zone 1 to open damper. Temporarily disconnect any other zone Remote Room Sensor (at sensor location). That zone damper will now open, while the Zone 1 damper will close.

**EXAMPLE:** If the Zone 2 Remote Room Sensor is disconnected, the Zone 2 damper will now open as indicated on the User Interface display. The word “FAIL” will also be displayed instead of the actual temperature for Zone 2. Reconnect Zone 2 sensor and try all remaining sensors one at a time in the system. Smart Sensors may also be checked, see Smart Sensor Installation Instructions for procedure.

#### Airflow Limits:

- LOW
- MEDIUM
- HIGH(default)
- MAXIMUM

Because there is no bypass damper, the Zone Airflow Limit check will allow the installer to assess the airflow noise generated by the system providing the maximum amount of airflow to each zone. Select ZONE, then select AIRFLOW LIMIT: Low, Medium, High (default), or Maximum. When Start is pressed (right side button), the selected zone’s damper will fully open, all others will close, and the indoor unit will provide the maximum airflow for that zone (as selected in SETUP — ZONING, Airflow Limits). If the airflow noise is objectionable, the installer can select a lower airflow noise limit. If the noise is not objectionable, the installer should leave High selected, or even Maximum.

**NOTE:** Selecting a lower airflow noise limit may decrease the homeowner’s comfort in that zone.

### Sensor Types:

Shows list of all zones with corresponding sensor types.

UI = User Interface

SS = Smart Sensor

RS = Remote Sensor

### Checkout - System Access Module (SAM)

See System Access Module Installation Instructions for full details.

## SERVICE MENUS

The Service Info menu will only show the equipment installed in the system. Below is a sample using a furnace and a heat pump (Hybrid Heat). A sample service menu is shown in Fig. 34.

SERVICE INFO	
FURNACE STATUS	
HEAT PUMP STATUS	
LAST 10 SYSTEM FAULTS	
RUN/FAULT HISTORY	
TODAY'S DATE	
MODEL/SERIAL NUMBER	
SERVICE PHONE NUMBER	
< BACK	SELECT >

A03205

Fig. 34 - Service Menu

### Service - Furnace Status or Gas PAC Status

The Status screens will show all of the current operating parameters of each installed piece of equipment.

**NOTE:** To view a less detailed Equipment Status screen, press and hold the right side button for 3 seconds. This will display equipment stage, fan status, actual and target humidify settings.

#### Heat Stage:

- OFF, LOW, HIGH

Displays stage of heat that the furnace is currently delivering.

#### Airflow CFM:

- (furnace model dependent)

Cubic Feet per Minute of air the User Interface is currently requesting.

#### Leaving Air Temp:

**This sensor is NOT required.** However, if LAT sensor is connected to the Damper Control Module, the sensor will read leaving air temperature of the furnace. The temperature information is for display purposes only. The system does not react to this temperature reading.

#### Indoor Coil Temp:

**This sensor is NOT required.** However, if HPT sensor is connected to the Damper Control Module, the sensor will read temperature at that location (i.e. if placed in return-air, will read return-air temperature). The temperature information is for display purposes only. The system does not react to this temperature reading.

#### Inducer RPM (90% furnaces only):

- Actual inducer motor RPM value.

#### Blower RPM:

- Actual blower motor RPM value.

#### Static Press:

- Inches of water. Displays calculated static pressure that the furnace is currently experiencing.
- If static pressure cannot be accurately calculated, the display will read UNKNOWN. When this is seen, the system is adjusting to

high static pressure by cutting back blower RPM.

**Lockout Timer:**

- Seconds

If a lockout timer is active, this will show the current time value. See furnace manual for details on lockout timers.

**Service - Fan Coil Status**

**Electric Heat:**

- OFF, LOW, MED, HIGH

Displays stages of electric heat that the fan coil is currently delivering.

**Airflow CFM:**

- (fan coil model number dependent)

Cubic Feet per Minute of air the User Interface is currently requesting.

**Leaving Air Temp:**

**This sensor is NOT required.** However, if LAT sensor is connected to the Damper Control Module, the sensor will read leaving air temperature of the fan coil. The temperature information is for display purposes only. The system does not react to this temperature reading.

**Indoor Coil Temp:**

**This sensor is NOT required.** However, if HPT sensor is connected to the Damper Control Module, the sensor will read temperature at that location (i.e. if placed down stream from evaporator coil, and before electric heat, will read coil leaving air temperature). The temperature information is for display purposes only. The system does not react to this temperature reading.

**Blower RPM:**

- Actual blower motor RPM value

**Static Press:**

- Inches of water. Displays the calculated static pressure the fan coil is currently experiencing.
- If static pressure cannot be accurately calculated, the display will read UNKNOWN. When this is seen, the system is adjusting to high static pressure by cutting back blower RPM.

**Service - Heat Pump / AC Status**

**Stage: (Heat / Cool)**

- OFF, LOW, HIGH

Displays stage of heating or cooling that the Heat Pump/AC is delivering.

**Defrost:**

- NO, YES

Displays status of defrost mode if heat pump.

**Airflow CFM:**

- Airflow User Interface is requesting from blower.

**Leaving Air Temp:**

**This sensor is NOT required.** However, if LAT sensor is connected to the Damper Control Module, sensor will read leaving air temperature of the indoor unit. The temperature information is for display purposes only. The system does not react to this temperature reading.

**Outdoor Coil Temp:**

- °F or °C (default = °F)

Temperature of the outdoor unit coil (only available on communicating outdoor units).

**Blower RPM:**

- Actual RPM feedback from indoor motor.

**Static Press:**

- Calculated static pressure of indoor unit.
- If static pressure cannot be accurately calculated, the display will read UNKNOWN. When this is seen, the system is adjusting to high static pressure by cutting back blower RPM.

**Service - Zoning Status**

**Zone Status:**

This screen will show each zone in the system with the corresponding damper position (POS), and CFM being delivered to each zone. Damper position range is from 0 to 15 (0 = closed, 15 = open).

**Service - Last 10 System Events**

LAST 10 EVENTS		
HP	3/2/05 2:35 PM	
LOW PRESSURE SWITCH OPEN		
3 EVENTS: ACTIVE		
FN	2/28/05 6:10 PM	F
41-BLOWER MOTOR FAULT		
225 EVENTS		
F=FAULT		
< BACK		MORE >

A07032

Fig. 35 - Last 10 System Events

This screen will show last 10 events that occurred throughout the system. Each entry has the time and date incident recorded. Service technician should enter current date in “TODAY’S DATE” menu section BEFORE checking and logging the last 10 system events. These events are stored in the memory of the User Interface and are resettable in the Thermostat Setup screen under the Reset Factory Default selection.

Each entry has a two-letter acronym preceding the event name to identify which piece of equipment generated the event. This event history can be cleared under Thermostat Setup, Reset Factory Defaults.

HP = Heat Pump

AC = Air Conditioner

FN = Furnace

FC = Fan Coil

ZN1 = Zone Board 1

ZN2 = Zone Board 2

SPP = Packaged product

SAM = System Access Module

**Service - Run / Fault History**

This information is stored in the equipment circuit boards (if communicating) and displayed on the User Interface. The indoor unit and outdoor unit (if communicating) have the following histories:

**NOTE:** For Critical Fault Screens, see Troubleshooting section in this document.

**Resettable Faults:**

- Fault counters for each piece of equipment that can be reset.

**Cycle Counters:**

- Number of heat/cool/power cycles the unit has performed.

**Run Times:**

- Lifetime hours of operation in heating, cooling, and how long the unit has been powered.

**Service - Today’s Date**

This menu item allows the installer to enter the current date. It is used for time/date stamping of system faults. This should be

entered every time prior to viewing “LAST 10 SYSTEM EVENTS” section.

### Service - Model / Serial Numbers

This menu item allows the installer to view the model number and serial number (if available) of all communicating pieces of equipment in the system. This information resides in the original circuit board from the factory. If a circuit board has been replaced, the model and serial number will no longer be displayed.

### Service - Service Phone Number

This menu item allows the installer to enter a name and phone number that the homeowner can call for future service of the system. This name and phone number will appear to the homeowner whenever a service reminder pop-up message is displayed (i.e. Change Filter, etc.)

To edit:

- Use Temp +/- button to move cursor left and right.
- Use Time +/- button to select numbers and letters.
- Use Scroll button to move up and down between NAME and NUMBER.

## OPERATIONAL INFORMATION

### Zone Selection

- Press top left ZONE button to select zones.

### Continuous Fan Operation

Pressing FAN button will scroll through the following:

- AUTO = No fan operation except during equipment operation.
- LOW = Approximately 50% of High Speed operation.
- MED = Half way between High and Low speed operation.
- HIGH = Highest of either High Heating or High Cooling CFM.

Continuous fan operation is programmable. The programming option must be enabled in the Thermostat Setup. See the Homeowner’s Manual for detailed instructions on programming the fan.

### Five-Minute Compressor Timeguard

This timer prevents compressor from starting unless it has been off for at least 5 minutes. It can be defeated by simultaneously pressing the Fan and Temp + buttons.

### Emergency Heat (for heat pump applications)

To activate Emergency Heat, you must press and hold the HEAT button for 3 seconds to activate. Repeat to deactivate.

### Heat Source Selection (Hybrid or Hydronic Heat)

If user wishes to override normal operation in Hybrid Heat or Hydronic Heat applications, press and hold the heat button for 3 seconds to select desired heat source.

### Keypad Lockout

Keypad can be locked by pressing “Fan” and “Humidity/Oat” buttons at the same time for 3 seconds. When keys are locked, a lock symbol will appear in the upper left corner of screen. Follow same procedure to unlock keypad.

### Heat and Cool LED

The Heat and Cool LEDs will pulsate during actual equipment operation. This can be defeated in the Advanced Setup Screens.

### Equipment Cycle Timer (adjustable 4-6 cycles per hour)

This timer prevents the start of a heating or cooling cycle until 15 (or 10) minutes after the last start of the same cycle. Its function is to assure that the equipment is not cycled more than the selected times per hour. This timer is adjustable from 4 to 6 cycles per hour. This timer is defeated for one cycle when the desired temperature is manually changed. It can also be defeated for one cycle by simultaneously pressing the Fan and Temp + buttons.

### Staging Timer

In multistage heating or cooling, this timer prevents any higher stage from turning on until the preceding stage has been on for 10 minutes.

In Hybrid Heat, the staging timer is 15 minutes between heat pump and gas furnace operation. A demand of 5°F/3°C or more will override the staging timer and allow higher stages to energize.

### Three-Minute Minimum On Time

In normal operation, when a stage turns on, it will remain on for a minimum of three minutes. If the setpoint is changed, this timer is automatically cancelled, allowing the equipment to turn off immediately when the demand is removed.

### Heat/Cool Setpoints (Desired Temperatures)

A minimum difference of 2°F/1°C (default) is enforced between heating and cooling desired temperatures. This is done by allowing one setting to “push” the other to maintain this difference. This difference is adjustable via the Install/Service menu under Thermostat Setup.

### Temperature Display

The actual temperature displayed is always rounded toward the setpoint. This is because the system is operating and measuring the temperature in sixteenths of a degree, but displaying in whole numbers. The system may be turned off and on within .5° of setpoint, but the display may not change. This is by design and does not indicate a problem with the control.

### Auto Changeover

When Auto mode is enabled (factory default) a change from heat to cool (or vice versa) will not occur until an opposite mode demand has existed for 30 minutes. If the setpoint is changed, the 30-minute requirement is defeated. This Auto Changeover time is adjustable via the Install/Service menu under Thermostat Setup. Range = 5 - 120 min.

### Smart Recovery

With Smart Recovery selected (factory default), transition out of setback begins 1.5 hours before selected recovery time and gradually adjusts room temperature so desired temperature will be achieved at selected recovery time. It operates in both heating and cooling. This only applies to programmable operation.

For example: Set back temperature in heating is 64°F. Smart Recovery setpoint is 70°F at 7:00 a.m. At 5:30 a.m., the control calculates the required temperature recovery rate (recovery temp - set back temp or current temp if greater) / 90 minutes. If the current temp at 5:30 = 66°F, the recovery rate = (70 - 66)°F/90 minutes = 0.04° per minute. In order to achieve setpoint, the control ramps up the setpoint 0.04 °F / minute from 5:30 a.m. until 7:00 a.m.

**NOTE:** Temperatures should not be set back so far that the equipment cannot recover in 90 minutes.

### Media Filter

If **MEDIA** or **MEDIA+EAC** is installed in the indoor unit, the system will perform a static pressure check of the system every 24 hours at 1:00 p.m. to monitor filter accumulation (TrueSense™ Dirty Filter Detection) or whenever power is applied to the system or the system is transitioned from Off to Cool or Heat modes. The blower will run at a medium airflow for one minute.

This system operates by setting a base line static pressure based on the highest airflow the system could run (this could be heat or cool airflow.) The measurement is taken at a low airflow and then calculated up to the highest airflow the system could see.

Selecting **MEDIA** will use TrueSense filter detection. Selecting **MEDIA+EAC** will use either TrueSense or the clean interval selection, whichever happens first.

## Unoccupied

Pressing the HOLD button for 3 seconds will set the selected zone to unoccupied status. A zone may also be programmed to be unoccupied in any period of the schedule. An unoccupied zone is used as a dump zone to alleviate high static or noise situations. Utilizing this feature will help keep occupied zones at acceptable temperatures and noise levels. The temperature in an unoccupied zone is controlled to a maximum and minimum settings that are selectable in the Advanced Setup. If the entire system is set to Unoccupied, the humidity is controlled within the range selected in the Unoccupied Advanced Setup. An unoccupied zone will be allowed to be conditioned up to the most conditioned zone setpoint, if necessary.

## All Zones

Pressing the ZONE button for 3 seconds will gray out the entire display and put the User Interface into “ALL ZONES” mode (indicated by “All Zones” in upper left of the display). Any changes to set temperature, fan, or Hold status will occur in all zones when the screen is exited. Press the ZONE button to exit “All Zones” mode.

## Frozen Coil Detection

During cooling operation, the User Interface will monitor the static pressure of the system. If the static pressure is increasing dramatically, the User Interface will turn off cooling for up to one hour, record fault in the “Last 10 Events” screen, and run the fan at a reduced airflow. The User Interface will continue to monitor the static pressure. If it is reduced before one hour has elapsed, it will resume cooling operation. After one hour, cooling will be resumed.

## Airflow Limits and Equipment Protection

The maximum airflow allowed into a zone is based on the relative size of the zone determined by the duct assessment and the airflow limits selected for each zone. Airflow limits are set at High as factory default. This means that 200% of assessed airflow is allowed into the zone.

Low = 100%; Med = 150%; Max = No Limit.

If the system determines that it cannot deliver the airflow into a zone that needs conditioning, and that zone has an airflow limit selected, the system will take the following 4 steps:

### Step 1 — Reduce airflow if possible

- 275 CFM per ton minimum in cooling. 175 CFM/ton for low stage cooling if 2-stage unit is installed.
- Comfort Heat airflow is minimum for heat pump heating (3.5 X Outdoor Temp + 137) CFM/ton.
- No adjustment for furnace heating

### Step 2 — Dump air to unoccupied zones

- Unoccupied zones can be conditioned up to the most conditioned setpoint.

### Step 3 — Dump air to zones with less conditioned setpoints

- Zones with lower setpoints in heating and higher setpoints in cooling may be conditioned to within 3°F / 1.7°C of the most conditioned setpoint.
- Increase or decrease unoccupied zones 0.75°F / .4°C.

### Step 4 — Single stage cooling

- System will reduce airflow to 175 CFM/ton in single stage cooling systems for 10 minutes to allow some cooling to be delivered when only a small zone is calling.

### Step 5 — Stage down equipment

- Equipment stage down or shut off if necessary.
- Fault history will record an event of “AIRFLOW LIMITED STAGEDOWN OCCURRED” on stagedown and “EXCESS STATIC PRESSURE” if shut down.

- If shut down occurs, other zones need to call before equipment will resume operation.

## Dehumidify Operation

Once a target cooling humidity setpoint is selected in the Advanced Setup COOLING HUMIDITY screen, two other setup options affect Dehumidify operation: AC AIRFLOW and DEHUMIDIFY.

**AC AIRFLOW:** This setting is located in the Furnace or Fan Coil Setup screens and must be set to **COMFORT** to enable dehumidify operation. Dehumidify operation is described as the ability to overcool the space while providing adequate airflow through equipment. If set to **EFFICIENCY** or **MAXIMUM**, no special dehumidify operation will take place. Cooling will only operate to satisfy the space temperature setpoint.

**DEHUMIDIFY:** Located in the Cooling Humidity screen of the Advanced Setup, this option has 2 settings: **ON** and **OFF**.

If DEHUMIDIFY is set to **ON** (factory default), then the cooling unit will be allowed to overcool the space up to 3°F / .6°C if the humidity level is above the cooling humidity target setpoint.

The amount of over-cooling allowed varies with the dehumidification demand, the cooling demand, and the actual space temperature. More over-cooling is allowed with greater dehumidification demand.

When the space temperature is at or above 75°F / 24°C and the dehumidify demand is high, over-cooling up to 3°F / 1.7°C is allowed. As the space temperature approaches 70°F / 21°C, less over-cooling is allowed. At 70°F / 21°C space temperature, no more over-cooling is allowed no matter how great the dehumidify demand. This is done to protect the equipment.

If DEHUMIDIFY is set to **OFF** and AC Airflow is set to **COMFORT**, normal dehumidification mode is enabled. For normal dehumidification, no over-cooling is allowed when the cooling humidity is above the target setpoint, but airflow will be reduced during a normal cooling mode to reduce humidity. The airflow depends on the amount of dehumidify demand. If AC Airflow is set to **EFFICIENCY** or **MAXIMUM**, only Dehumidify (over-cooling to dehumidify) will be performed

## Hybrid Heat Setup / Operation

**Furnace Lockout Operation** — (in HYBRID HEAT SETUP menu) is the outside temperature above which the furnace will not run except for defrost (otherwise known as the aux heat lockout).

**Heat Pump Lockout Operation** — (in HYBRID HEAT SETUP) is the outside temperature below which the heat pump will not run (otherwise known as the balance point).

These values can be set identical to each other. If they are not identical, the system will stage up and down normally from heat pump to furnace when the outside temperature is between these settings. The User Interface will not allow the heat pump lockout setting to be above the furnace lockout setting.

The factory default settings for both of these is NONE (no lockouts). Even though a furnace lockout temperature may be set, the system will still use the furnace in defrost operation, and may stage back down to heat pump when defrost is completed after a 2 minute delay.

**Hybrid Heat Defrost** — (in HYBRID HEAT SETUP) When the outdoor unit needs a defrost cycle, the furnace will run during defrost regardless of lockout temperature, unless told not to in the Hybrid Heat Setup screen. After defrost, the system may stage down to heat pump after a 2 minute delay.

## TROUBLESHOOTING

Please refer to the Troubleshooting Guide available on HVAC Partners for more detail.

### **Infinity Zone Control does not power up.**

1. Recheck wiring to ABCD on all devices.
2. Make sure all colors match for every terminal.
3. Make sure power is applied to the indoor unit, and the amber LED is lit on indoor control circuit board.
4. Check for 24VAC between the C and D terminals at Infinity Zone Control terminal connector and Damper Control Module.
5. Check fuse on indoor unit's circuit board.

### **Display says “Indoor Unit Not Found”**

1. Recheck wiring to ABCD on all devices.
2. Make sure all colors match for every terminal.
3. Press left-side button to try again.
4. If display still reads “Indoor Unit Not Found”, disconnect accessories and all devices from ABCD and connect User Interface directly to indoor unit with a short piece of thermostat wire. Add other devices one at a time to determine where the communication issue exists.

### **Display says “Outdoor Unit Not Found”, and I have a two-stage communicating outdoor unit.**

1. Recheck wiring to ABCD connector on outdoor unit.
2. Make sure all colors match for every terminal.
3. Check for 24VAC between the C and D terminal connector of outdoor unit.

### **I made a mistake on the start-up screens, and hit the right-side button to get to the run mode. How do I get back to start-up?**

1. Press the ADVANCED button for at least 10 seconds.
2. Install/Service menu will appear.
3. Scroll down to the INSTALL selection.
4. Press the right-side button; the screen will prompt you to press the right side again to re-install the system.

### **Control does not see zones 5 through 8.**

1. Make sure zone module 5 - 8 has the DIP switches set to the right.
2. Recheck wiring to the ABCD connectors.

### **Control says I have zones 5 - 8 but not 1 - 4.**

1. Make sure zone module 1 - 4 has the DIP switches set to the left.
2. Recheck wiring to the ABCD connectors.

### **Some zones in my zoned system do not provide enough comfort. (A noticeable difference exists between the actual room temperature and operating setpoint, yet the equipment does not turn on).**

1. The zone airflow limit may be set too low. Perform the Zone Airflow Limit Checkout procedure, raise airflow limit setting, if possible.

### **Some zones provide too much airflow and are noisy.**

1. The zone airflow limit may be set too high. Perform the Zone Airflow Limit Checkout procedure, lower airflow limit setting if possible.

### **To check current system status.**

1. Press and hold the right side button for 3 seconds. This will display the current active system faults.
2. If no faults are active, the Status screen will show status of each component in the system.

## SYSTEM MALFUNCTION SCREEN



Fig. 36 - System Malfunction Screen

A07036

### Fan Coil

The code number represents flash code on circuit board of fan coil. Certain faults will generate a system malfunction message on the main screen. When this occurs, a technician should proceed to the Last 10 System Events screen in the Service Menu to determine which fault has caused the message.

A new feature in the -B model is that the Status screen (right side button press for 3 seconds) will reveal the active fault to the homeowner.

Below is a list of which faults will result in a System Malfunction event:

Code 37 - Heater output sensed On when not energized

Code 41 - Blower Motor Fault (ventilator, humidifier, dehumidifier, outdoor unit will be turned off)

Code 44 - Motor Communication Fault (ventilator, humidifier, dehumidifier, outdoor unit will be turned off)

Code 45 - Control failure

### Furnace

The code number represents flash code on circuit board of furnace.

Code 13 - Limit Circuit Lockout

Code 14 - Ignition Lockout

Code 15 - Blower Motor Lockout (ventilator, humidifier, dehumidifier, outdoor unit will be turned off)

Code 21 - Gas Heating Lockout

Code 22 - Abnormal Flame Proving Signal

Code 23 - Pressure Switch Did Not Open

Code 24 - Secondary Voltage Fuse Open

Code 33 - Limit Circuit Fault AND high heat only is active

Code 41 - Blower Motor Fault (cooling mode only) (ventilator, humidifier, dehumidifier, outdoor unit will be turned off)

Code 45 - Control Circuitry Lockout

**NOTE:** For codes 13, 14 and 21, the system will use heat pump heating exclusively if available. When the error code is cleared or disappears, furnace heating will resume if still requested.

### Outdoor Unit

The code number represents flash code on circuit board of outdoor unit.

Code 45 - Control Failure

Code 47 - No 230V at unit

Code 73 - Contactor shorted

Code 74 - No high voltage at compressor

Code 76 - Low stage didn't start three times

Code 78 - High stage didn't start three times

Code 79 - Run capacitor failed

Code 81 - Thermal lockout in low stage - 4 hrs.

Code 82 - Thermal lockout in high stage - 4 hrs.

Code 83 - Low Pressure Lockout - 4 hrs.

Code 84 - High Pressure Lockout - 4 hrs.

Code 85 - Low contactor open

Code 86 - Low contactor shorted

Code 87 - High contactor open

Code 88 - High contact shorted

Code 89 - Start Capacitor / Relay Failed

### User Interface

- Temp sensor failed, loss of communication with smart sensor, smart sensor fault. "NO SENSOR DATA" shown
- Indoor unit communication fault
- Outdoor unit communication fault
- Packaged product communication fault
- NIM communication fault
- SAM communication fault
- Possible Frozen Coil
- High Room Temp Alert, when 100°F/38°C exists for at least 10 minutes, and removed when less than or equal to 98°F/37°C exists
- Low Room Temp Alert, when 38°F/3°C exists for at least 10 minutes, and removed when greater than or equal to 40°F/4°C exists
- High Humidity Alert, when 80% Rh exists for 30 minutes, and removed when less than or equal to 78% Rh exists

The user can press the right side button to dismiss the notice. The regular run mode screen will then appear except "SYSTEM MALFUNCTION" will appear in place of the day/time. If the error has not disappeared within 24 hours, the above display will return. If the error code disappears, "SYSTEM MALFUNCTION" will disappear and the day/time will reappear.

